



SPIL®

L'eccellenza in cartoleria

CATALOGO
VII EDIZIONE



L'eccellenza in CARTOLERIA

L'AZIENDA

PRODOTTI DI QUALITÀ PER LA SCUOLA
E PER L'UFFICIO



L'eccellenza in Cartoleria

Da una attenta analisi del mercato stationery richiedente articoli innovativi per la scuola e per l'ufficio che avessero qualità e competitività dei prezzi, nel 2007, nasce il marchio SPIL.

Il core business dell'azienda e' sempre stato

- 1) Accurata selezione e realizzazione dei prodotti
- 2) Attenzione meticolosa al design e al packaging
- 3) Staff aziendale qualificato e competente per rispondere ad ogni esigenza del cliente
- 4) Distribuzione dei propri prodotti solo ed esclusivamente a rivenditori di settore

SPIL propone una vasta gamma di prodotti che affascinano per la vivacità dei colori, per la solidità e affidabilità dei propri componenti, per la competitività dei prezzi sul mercato e si posiziona così come una eccellenza stationery presente nelle migliori cartolerie italiane.



Dove Siamo



SEDE OPERATIVA:

ZONA P.I.P. 83030 • Melito Irpino (AV)

SEDE LEGALE:

Piazza G. Capasso, 16 • Melito Irpino (AV)

WEB:

spil-italia.com

FACEBOOK:

facebook.com/spil.spilitalia

INSTAGRAM:

instagram.com/spil_italia

CENTRALINO: 0825 446649

FAX: 0825 426898

UFFICIO: 338 7966040

MAGAZZINO: 342 5132238 • 351 8290676

E-MAIL:

AMMINISTRAZIONE

c.giorgio@spil-italia.com

COMMERCIALE

r.beatrice@spil-italia.com

VENDITA



































ordini@spil-italia.com

INFORMAZIONI

info@spil-italia.com

LEGENDA

COLORI:

 AG ARAGOSTA	 BL BLU	 GL GIALLO	 RS ROSSO
 AR ARANCIONE	 BLM BLU METALLIZZATO	 GLF GIALLO FLUO	 VL VIOLA
 ARF ARANCIONE FLUO	 BLN BLU NAVY	 GR GRIGIO	 VLF VIOLA FLUO
 ARG ARGENTO	 BN BIANCO	 LI LILLA	 VM VERDE MELA
 AN AVANA	 BO BORDEAUX	 MA MAGENTA	 VR VERDE
 ANS AVANA SEALING	 CL CELESTE	 MR MARRONE	 VRF VERDE FLUO
 AV AVORIO	 CI CIELO	 NE NERO	 VRC VERDE CHIARO
 AZ AZZURRO	 FC FUCSIA	 ORO ORO	
 AZF AZZURRO FLUO	 OC OCRA	 RO ROSA	

DICITURE:

RIG. = RIGATURA
UMV = UNITÀ MINIMA DI VENDITA
VAR. = VARIAZIONE
C/F = CON FORI
S/F = SENZA FORI
ASS = ASSORTITO
ESP. = ESPOSITORE
FT = FORTE
TN = TENUE
RU = RUVIDO
LI = LISCIO
RI = RIQUADRATO

STD = STANDARD
TR = TRASPARENTE
MIC = MICRON
D.SO = DORSO
COL. = COLORE
MOD. = MODELLO
DIM. = DIMENSIONE
RFID = RADIO FREQUENCY
IDENTIFICATION
NFC = NEAR FIELD COMMUNICATION
PP = POLIPROPILENE
PPL = POLIPROPILENE

FORMATI:

A0+ = H106,7 cm
A0 = H91 cm
A1+ = H62,5 cm
A1 = H61 cm
A2 = H42 cm
A3 = 29,7*42 cm

A4 = 21*29,7 cm
A4 + = 22,5*29,7 cm
A5 = 14,8*21 cm
A6 = 10*15 cm
A7 = 8*12 cm
A9 = 9*12 cm

Sommario

SCRITTURA (1)	1		
PENNE	2		
EVIDENZIATORI	17		
PENNARELLI.....	26		
CORRETTORI.....	34		
DISEGNO (2)	37		
COLORI.....	38		
MATITE.....	47		
TEMPERAMATITE	50		
GOMME.....	53		
BLOCCHI DISEGNO.....	56		
SQUADRE-RIGHE	58		
COMPASSI.....	64		
FORBICINE	74		
CARTELLE PORTA DISEGNI ...	76		
CARTOTECNICA (3)	81		
MAXI QUADERNO MONOCOLORE	84		
MAXI QUADERNO CARTONATO.....	89		
QUADERNI A5.....	89		
RUBRICHE	90		
RICAMBI	91		
MAXI QUADERNO MUSICA.....	92		
QUADERNI LABORATORIO.....	93		
CARTA PROTOCOLLO.....	94		
SPILNOTES.....	95		
PORTA BLOCCHI	98		
SPILBLOK (4)	101		
SPILBLOK4.....	106		
SPILBLOKQ	109		
SPILBLOK5.....	113		
SPILBLOK6.....	113		
SPILBLOK7.....	113		
SPILBLOK9.....	114		
SPILBLOK1.....	117		
		SPILBLOK2.....	117
		COPRILIBRI E COPRIMAXI (5)	121
		COPRILIBRI.....	122
		COPRIMAXI.....	123
		ETICHETTE PER LIBRI.....	124
		CALCOLATRICI (6)	127
		TASCABILI.....	128
		DA BANCO	132
		SCIENTIFICHE.....	135
		DIDATTICA (7)	139
		FORBICINE.....	140
		ABACO	142
		REGOLI.....	142
		BLOCCHI LOGICI.....	143
		COLLE E COLLANTI (8)	145
		GEL STIK.....	146
		COLLA VINYL.....	146
		COLLA LIQUIDA	147
		COLLA GLITTER	148
		GLITTER.....	150
		SUPER GLUE	151
		TRA TAK.....	151
		PICIKO.....	151
		PISTOLA A CALDO	152
		NASTRO TRASPARENTE	154
		NASTRO IMBALLO	155
		DISPENSER.....	156
		NASTRO BIADESIVO	157
		NASTRO INVISIBILE	158
		NASTRO CARTA.....	158
		NASTRO ISOLANTE	158
		NASTRO TELATO.....	159
		NASTRO SEGNALATORE	159
		ETICHETTE IN BUSTA.....	160
		ETICHETTE IN A4.....	162
		PREZZATRICI	166

IMBALLAGGIO (9)

PLURIBALL.....	170
FILM ESTENSIBILE.....	170
CARTA DA IMBALLO.....	171

CUBOTTI E STIKI MEMO (10)

BLOCCHI NUMERATI.....	174
PLANNING.....	174
Q.BO.....	174
SEGNA PAGINE.....	175
STIKI MEMO.....	176

SPILLATRICI E**ACCESSORI (11)**

SPILLATRICI.....	182
PUNTI PER SPILLATRICI.....	185
LEVAPUNTI.....	186
PERFORATORI.....	187
FORBICI.....	188
CUTTER.....	189
FERMAGLI.....	190
PUNTINE.....	190
SPILLI CARTOGRAFICI.....	191
BINDER CLIP.....	191
UMIDIFICATORE.....	191

ACCESSORI (12)

CARTELLI VARI.....	194
CARTELLI SEGNA PREZZO.....	195
ELASTICI.....	197
PORTA BLOCCHI.....	198
ELIMINA CODE.....	200
REGGI LIBRI.....	202
PREZZATRICI.....	203
UMIDIFICATORE.....	205

ARCHIVIO (13)

PORTA PROGETTO.....	208
CARTELLE ELASTICO.....	210
CARTELLE A SCOMPARTI.....	213
CARTELLE CON LEMBI.....	214
CARTELLE SENZA LEMBI.....	215
CARTELLE CON FINESTRA.....	215
CARTELLE PRODUZIONE.....	215
CARTELLE CON ANELLI.....	216

BUSTE CON FORATURA

UNIVERSALE.....	220
BUSTE TRASPARENTI AD L.....	221
DIVISORI ED INTERCALARI.....	221
BUSTE CON BOTTONE.....	222
BUSTE CON ZIP.....	224
PORTA TESINA.....	226
PORTA LISTINI.....	226
PORTA DOCUMENTI ITALY.....	228
PORTA DOCUMENTI CLASSIC.....	229
CARTELLE CON LEGACCIO....	230
CARTELLE SOSPESE.....	231

LAVAGNE (14)

LAVAGNE MAGNETICHE.....	234
LAVAGNE IN SUGHERO.....	236
PENNARELLI PER LAVAGNE....	237
SPILLI CARTOGRAFICI.....	238
CANCELLINI.....	238

PORTA DOCUMENTI (15)

PORTA CARDS.....	242
ETICHETTE PER BAGAGLI.....	250
PORTA DOCUMENTI.....	251

CARTE SPECIALI (16)

CARTONCINI CHARTAE.....	256
CARTONCINI GOFFRATI.....	256
CARTA PERGAMENATA.....	257
CARTONCINI MOMENTI.....	258

RILEGATURA (17)

COPERTINE IN PVC.....	262
POUCHES PER PLASTIFICAZIONE.....	262
NASTRO INVISIBILE.....	263
NASTRO TELATO.....	263
RILEGATRICE.....	264
DORSINI IN PLASTICA.....	265
SPIRALI IN PLASTICA.....	266

CARTA E ROTOLI (18)

CARTA PER FOTOCOPIE.....	274
ROTOLE PER CASSA.....	275
ROTOLE PER POS.....	275

ROTOLI PER PLOTTER.....	276
ROTOLI PER XEROX.....	276
OPALINE E	
BUSTE PER SPEDIZIONE (19)	279
OPALINE	280
BUSTE IMBOTTITE.....	285
BUSTE SPEDIZIONE.....	286
CORNICI (20)	291
CORNICI A GIORNO	292
CORNICI PIATTINA.....	292
CORNICI ARTE POVERA	293
CORNICI BURN.....	293
CONFEZIONAMENTO (21)	295
BUSTE DA REGALO	296
BUSTE PORTA BOTTIGLIE	303
SCATOLE DA REGALO	305
CARTA DA IMBALLO	307
PALLONCINI (22)	309
PALLONCINI AD ELIO	310
PALLONCINI AD ARIA.....	310
PALLONCINI MODELLABILI.....	312
HOBBISTICA (23)	315
FORME IN PLASTICA	316
FORME IN POLISTIROLO	321
COLLE GLITTER.....	328
GLITTER.....	331
IGIENIZZANTI (24)	333
ESPOSITORI (25)	337
MODULO ORDINI (26)	363

PENNE SCORREVOLI PER IDEE BRILLANTI

$\lim_{x \rightarrow -\infty} (2x - 3x^2) = -\infty$
 $\lim_{x \rightarrow \infty} (2x - 3x^2) = -\infty$
 $\lim_{x \rightarrow \infty} \frac{-3x^2}{-3x^2 - 5} = 1$
 $\lim_{x \rightarrow 0} \frac{\cos 5x - 1}{\sin 5x} = \frac{0}{0}$, limite notevole di riferimento $\lim_{x \rightarrow 0} \frac{\cos x - 1}{x} = 0$
 $\lim_{x \rightarrow 2} \frac{8 - x^3}{3x^3 - 9x^2 + 3x + 6} = \frac{0}{0} \Rightarrow \lim_{x \rightarrow 2} \frac{(2-x)(4+2x+x^2)}{(x-2)(3x^2-3x-3)} = -1$
 $\lim_{x \rightarrow -\infty} \frac{-3x^5 - x^4 + 1}{x^3 + x^2 + 5} = \lim_{x \rightarrow -\infty} \frac{x^5(-3 - \frac{1}{x^4} + \frac{1}{x^5})}{x^3(1 + \frac{1}{x} + \frac{5}{x^3})} = -\infty$
 $\lim_{x \rightarrow 0} \frac{-4x}{\log(1 - \sqrt{3}x)} = \frac{0}{0}$, limite notevole di riferimento $\lim_{x \rightarrow 0} \frac{x}{\log(1+x)} = 1$
 $\lim_{x \rightarrow 0} \frac{-\sqrt{3}x}{\log[1 + (-\sqrt{3}x)]} = \frac{4}{\sqrt{3}} = \frac{4\sqrt{3}}{3} \cdot \frac{1}{\log e} = \frac{4\sqrt{3}}{3} \ln \sqrt{2}$
 $B = \{c\}$; se A è dominio
 I due funzioni



GRAPA 1.0

SCRITTURA

PENNE	2
EVIDENZIATORI.....	17
PENNARELLI.....	26
CORRETTORI	34



Magika



PENNA
CANCELLABILE

Cod. 14470/NR

Cod. 14470/BL

Cod. 14470/RS

Cod. 14470/VR

1
U.M.V.

144
Imballo

Cod. 14470/ESP

1
U.M.V.

20
Imballo

Penna cancellabile con **8 grammi di inchiostro termosensibile**, impugnatura antiscivolo e due gomme in silicone: una sul tappo e una sul fusto. **Punta 0.7 mm.** Confezione da 12 pezzi per singolo colore, espositore da 36 pezzi assortiti (12 nero, 12 blu, 12 rosso)

PUNTA
0,7



Espositore **Magika**



REFILL Magika

Cod. 14475/NR

Cod. 14475/BL

Cod. 14475/RS

Cod. 14475/VR

1
U.M.V.

24
Imballo

Refill cancellabile con **8 grammi di inchiostro termosensibile**, per penne MAGIKA e MAGIKLIK, compatibile con altre penne cancellabili. **Punta 0.7 mm.** Blister da 3 pezzi colore singolo, in confezione da 24 blister.

PUNTA
0,7

Magixolor

Penna cancellabile in 4 colori, inchiostro termosensibile, **punta 0.7 mm**, impugnatura antiscivolo, gomma in silicone sul fusto. Confezione da 12 pezzi per singolo colore. Espositore da 36 pezzi assortiti (9 lilla, 9 arancio, 9 fuxia, 9 azzurro)



PENNA
CANCELLABILE

Cod. 55262/AR

1
U.M.V.

144
Imballo

Cod. 55262/ESP

1
U.M.V.

20
Imballo

PUNTA
0,7



Espositore **Magixolor**



Magixlik

Penna a scatto cancellabile con inchiostro gel termosensibile, gomma in silicone, **punta 0.7 mm**. Confezione da 12 pezzi per singolo colore, espositore da 36 pezzi assortiti (12 blu, 12 rosso, 6 nero, 6 verde)



PENNA
CANCELLABILE

Cod. 55261/NR

Cod. 55261/BL

Cod. 55261/RS

Cod. 55261/VR

1
U.M.V.

72
Imballo

PUNTA
0,7

Cod. 55261/ESP

1
U.M.V.

20
Imballo



Espositore **Magixlik**



simple RT

Penna a scatto con **inchiostro semi-gel, punta 1.0 mm**, fusto semitrasparente e lati gommati per facilitarne l'impugnatura. Confezione in colori singoli da 12 pezzi, espositore da 36 pezzi assortiti (12BL/12NR/12RS).



Cod. 14472/NR

Cod. 14472/BL

Cod. 14472/RS

1
U.M.V.

40
Imballo

PUNTA
1,0

Cod. 14472/ESP

1
U.M.V.

20
Imballo

Espositore **simple
RT**



Cod. 14471/NR

Cod. 14471/BL

Cod. 14471/RS

1
U.M.V.

40
Imballo

Cod. 14471/ESP

1
U.M.V.

20
Imballo

simple CAP

Penna con **inchiostro semi-gel, punta 1.0 mm**, tappo e fusto trasparente. Confezione in colori singoli da 50 pezzi, espositore da 36 pezzi assortiti (12BL/12NR/12RS).

PUNTA
1,0

Espositore **simple
CAP**

smooth sfera

Penna a scatto, **punta 1.0 mm**, impugnatura grip, con clip.
Confezione in colori singoli da 12 pezzi, espositore da 36 pezzi assortiti (12BL/12NR/12RS).

Cod. 28086/NR

Cod. 28086/BL

Cod. 28086/RS

1
U.M.V.

144
Imballo

PUNTA
1,0

Cod. 28086/ESP36

1
U.M.V.

20
Imballo



Espositore **smooth**
sfera



smooth gel

Penna a scatto, inchiostro gel, **punta 1.0 mm**, impugnatura grip, con clip. Confezione in colori singoli da 12 pezzi, espositore da 36 pezzi assortiti (12BL/12NR/12RS).

Cod. 07385/NR

Cod. 07385/BL

Cod. 07385/RS

1
U.M.V.

144
Imballo

PUNTA
1,0

Cod. 07385/ESP

1
U.M.V.

20
Imballo



Espositore **smooth**
gel



AGUJA

Penna **gel**, punta **0.4 mm**, tappo con clip, confezione da 12 pezzi per singolo colore, espositore da 36 pezzi (12 nero, 12 blu e 12 rosso).

Cod. 20073/NR

Cod. 20073/BL

Cod. 20073/RS



U.M.V.



144
Imballo

PUNTA
0,4

Cod. 20073/ESP



U.M.V.



20
Imballo



Espositore AGUJA



KÜMÎ

Penna **roller gel** con sistema di erogazione 'free ink', punta **0.7 mm**, fusto gommato e tappo con clip in metallo. Confezione da 12 pezzi per singolo colore, espositore da 36 pezzi assortiti (12BL/12NR/12RS).

Cod. 14474/NR

Cod. 14474/BL

Cod. 14474/RS



1
U.M.V.



144
Imballo

PUNTA
0,7

Cod. 14474/ESP



1
U.M.V.



20
Imballo



Espositore KÜMÎ

karàgrip

Penna **sfera a scatto**, punta **1.0 mm**. Espositore 144 pezzi assortiti (20 nero, 20 blu, 20 rosso, 12 azzurro, 12 rosa, 12 viola, 12 arancio, 12 giallo, 12 verde chiaro, 12 verde scuro). Confezione singola da 50 pezzi nei colori nero, blu e rosso.

Cod. 55260/NR

Cod. 55260/BL

Cod. 55260/RS

1
U.M.V.

144
Imballo

PUNTA
1,0

Cod. 55260/ESP

1
U.M.V.

20
Imballo



Espositore **karàgrip**



RICIKLA

Penna **sfera a scatto**, punta **1.0 mm**. Confezione da 12 pezzi per singolo colore, espositore da 36 pezzi assortiti (12 nero, 12 rosso, 12 blu).

Cod. 55259/NR

Cod. 55259/BL

Cod. 55259/RS

1
U.M.V.

144
Imballo

PUNTA
1,0

Cod. 55259/ESP

1
U.M.V.

20
Imballo



Espositore **RICIKLA**

SPIL ALPHA

0.5



scatto
silenzioso

impugnatura
MORBIDA ED ERGONOMICA
ANTI AFFATICAMENTO

PUNTA ST 0.5
inchiostro Gel Nero



DISPLAY DA
72 POZZI

CODICE ARTICOLO : 22590/072



GRADIENT 0.5

SILENT CLICKER GEL PEN



TWIN BALL
TIP 0.5
INCHIOSTRO GEL NERO

PUNTO SOFT TOUCH
CON PORO PER VEDERE
IL LIVELLO DEL INCHIOSTRO

SCATTO
SILENZIOSO

DISPLAY DA
72 PEZZI



CODICE ARTICOLO : 22593/072

Otri

Penna sfera a scatto, punta 0.7 mm, impugnatura triangolare. Confezione da 50 pezzi per singolo colore, espositore da 36 pezzi assortiti (12 blu, 12 rosso, 12 nero)

Cod. 55258/NR

Cod. 55258/BL

Cod. 55258/RS

1
U.M.V.

144
Imballo

PUNTA
0,7

Cod. 55258/ESP

1
U.M.V.

20
Imballo



Espositore Otri



GRAPA

Penna **sfera**, scrittura scorrevole, **punta 1.0 mm**.
 Confezione da 50 pezzi per singolo colore.

Cod. 20304/NR

Cod. 20304/BL

Cod. 20304/RS

Cod. 20304/VR

PUNTA
1,0

1
U.M.V.

40
Imballo



GRAPA neon

Penna **sfera**, scrittura scorrevole, **punta 1.0 mm**.
 Blister da 6 pezzi assortiti: giallo, arancio, fucsia, verde, celeste, viola.

Cod. 20305/6



PUNTA
1,0

1
U.M.V.

24
Imballo



SIGNA

Penna gel, punta da 1,0 mm, fusto cromato e gommato.
Confezione da 36 pezzi: 24 nere, 12 blu.

Cod. 23719/ESP

1
U.M.V.

18
Imballo

PUNTA
1,0



Espositore **SIGNA**



SEAL

Penna gel, punta da 0,5 mm, fusto traslucido, finiture cromate e scrittura fine. Confezione da 36 pezzi: 24 nere, 12 blu.

Cod. 23766/ESP

1
U.M.V.

18
Imballo

PUNTA
0,5



Espositore **SEAL**



RAPIDO

Penna **gel super fluida**, punta **0.7 mm**, impugnatura triangolare in gomma, confezione da 12 pezzi per singolo colore, espositore da 36 pezzi assortiti (12 nero, 12 blu e 12 rosso).

Cod. 20142/NR

Cod. 20142/BL

Cod. 20142/RS

1
U.M.V.

144
Imballo

PUNTA
0,7

Cod. 20142/ESP

1
U.M.V.

20
Imballo



Espositore **RAPIDO**



SIYA

Penna **semi-gel**, punta **0.7 mm**, tappo con clip, fusto semitrasparente e impugnatura gommata. Confezione da 12 pezzi per singolo colore, espositore da 36 pezzi assortiti (12BL/12NR/12RS).

Cod. 14473/NR

Cod. 14473/BL

Cod. 14473/RS

1
U.M.V.

144
Imballo

PUNTA
0,7

Cod. 14473/ESP

1
U.M.V.

20
Imballo



Espositore **SIYA**

ZERO4

FINELINER 0.4

Penna con **punta fina 0.4 mm**, ideale per la scrittura e il disegno, asciugatura rapida, sistema di rilascio fluido dell'inchiostro per una scrittura perfetta.



Cod. 22568/01	Cod. 22568/11
Cod. 22568/02	Cod. 22568/12
Cod. 22568/03	Cod. 22568/13
Cod. 22568/04	Cod. 22568/14
Cod. 22568/05	Cod. 22568/15
Cod. 22568/06	Cod. 22568/16
Cod. 22568/07	Cod. 22568/17
Cod. 22568/08	Cod. 22568/18
Cod. 22568/09	Cod. 22568/19
Cod. 22568/10	Cod. 22568/20

1 U.M.V. 12 Imballo 12 Pezzi



Espositore penne con
punta fina 0.4 mm, 360
pezzi assortiti.

Cod. 22568/ESP

1 U.M.V. 1 Imballo

PUNTA
0,4



Le penne Magika sono perfette per i bambini che amano colorare e scrivere. Sono cancellabili e disponibili in diverse colorazioni vivaci e accattivanti, perfette per stimolare la creatività dei bambini.

La punta delle penne è sottile e precisa, ideale per scrivere e disegnare con precisione. Il corpo delle penne è ergonomico e facile da impugnare anche per i più piccoli.

Le penne Magika sono uno strumento indispensabile per l'apprendimento e il divertimento dei bambini.



Cod. 14470/ASS

 1 U.M.V.
  1 Imballo
  300 Pezzi

PENNA CANCELLABILE MAGIKA BLU DA 12
 PENNA CANCELLABILE MAGIKA NERO DA 12
 PENNA CANCELLABILE MAGIKA ROSSO
 PENNA CANCELLABILE MAGIKA VERDE DA 12
 PENNA MAGIKOLOR DA 36 PEZZI ASSORTITI
 REFILL CANCELLABILE MAGIKA BLU DA 3 PEZZI
 REFILL CANCELLABILE MAGIKA NERO DA 3 PEZZI

6 CONF.
 4 CONF.
 6 CONF.
 2 CONF.
 1 DA 36PZ
 24 CONF.
 12 CONF.

REFILL CANCELLABILE MAGIKA ROSSO DA 3 PEZZI
 REFILL CANCELLABILE MAGIKA VERDE DA 3 PEZZI
 PENNA MAGICLIK 0.7 DA 12 PZ BLU
 PENNA MAGICLIK 0.7 DA 12 PZ NERO
 PENNA MAGICLIK 0.7 DA 12 PZ ROSSO
 PENNA MAGICLIK 0.7 DA 12 PZ VERDE

24 CONF.
 6 CONF.
 3 CONF.
 2 CONF.
 3 CONF.
 1 CONF.



Le nostre penne sono progettate per essere eleganti, funzionali e resistenti. Proposte in una vasta gamma: gel, roller, semi-gel, sfera, gel super fluido.



Espositore vuoto, foto puramente indicativa.

Cod. 54731/30





Spillumina

CONTENUTO
4g

Evidenziatore **punta a scalpello** in 6 colori brillanti. Impugnatura antiscivolo, tappo con clip, **4g di inchiostro**. Confezione colori singoli da 10 pezzi, espositore da 36 pezzi assortiti (12 giallo, 6 arancio, 6 verde, 6 fucsia, 3 azzurro, 3 lilla).



Espositore Spillumina

Cod. 28487/AZ

Cod. 28487/LI

Cod. 28487/AR

Cod. 28487/GL

Cod. 28487/FC

Cod. 28487/VR

1
U.M.V.

80
Imballo

Cod. 28487/ESP

1
U.M.V.

4
Imballo



SPILLUMINA PASTEL

Evidenziatore **punta soft a scalpello** in 6 colori pastello. Confezione colori singoli da 12 pezzi, espositore da 36 pezzi assortiti, 6 pezzi per colore.



Espositore SPILLUMINA PASTEL

Cod. 20060/01

Cod. 20060/02

Cod. 20060/03

Cod. 20060/04

Cod. 20060/05

Cod. 20060/06

1
U.M.V.

10
Imballo

Cod. 20060/ESP

1
U.M.V.

4
Imballo



spillumina round

CONTENUTO
5g

Evidenziatore a fusto tondo, **punta a scalpello**. 5 g di inchiostro. Confezione 12 pezzi per singolo colore, display 36 pezzi assortiti (6 per colore)



Espositore spillumina
round

Cod. 54318/AZ

Cod. 54318/LI

Cod. 54318/AR

Cod. 54318/GL

Cod. 54318/RO

Cod. 54318/VR

1
U.M.V.

72
Imballo

Cod. 54318/ESP

1
U.M.V.

4
Imballo



PUNTA A SCALPELLO
MORBIDA

luminasoft

Evidenziatore a penna con **punta scalpello morbida**. Fusto trasparente e tappo con clip. Confezione in colori singoli da 12 pezzi, espositore da 36 pezzi assortiti (6 pezzi per colore).



Espositore luminasoft

Cod. 54317/AZ

Cod. 54317/LI

Cod. 54317/AR

Cod. 54317/GL

Cod. 54317/FC

Cod. 54317/VR

1
U.M.V.

72
Imballo

Cod. 54317/ESP

1
U.M.V.

4
Imballo



Spil Lumina 2.0

CONTENUTO
3g

Evidenziatore **punta a scalpello**, tappo con clip, **3 g di inchiostro**. Confezione da 12 pezzi per singolo colore, espositore da 36 pezzi assortiti (6 per colore).



Espositore *Spil Lumina 2.0*

- Cod. 55113/AZ
- Cod. 55113/LI
- Cod. 55113/AR
- Cod. 55113/GL
- Cod. 55113/RO
- Cod. 55113/VR

U.M.V. 1 Imballo 72

Cod. 55113/ESP

U.M.V. 1 Imballo 4



spillumina|grip

CONTENUTO
4g

Evidenziatore **punta a scalpello**, fusto gommato, **4 g di inchiostro**. Confezione da 12 pezzi, espositore da 36 pezzi assortiti (12 giallo, 6 fuxia, 6 verde, 6 azzurro, 6 arancio).



Espositore spillumina|grip

- Cod. 55257/GL
- Cod. 55257/AR
- Cod. 55257/AZ
- Cod. 55257/VR
- Cod. 55257/FC

U.M.V. 1 Imballo 72

Cod. 55257/ESP

U.M.V. 1 Imballo 4



BRILLO Mini

Cod. 19969/01



1

U.M.V.



12

Imballo



Mini evidenziatori colori fluo, **punta soft retinata** che ne garantisce durata e colore sempre vivace, 4 grammi d'inchiostro.
Confezione da 6 pezzi assortiti: fucsia, giallo, verde, azzurro, viola, arancio.



CANDY Mini

Cod. 19969/02



1

U.M.V.



12

Imballo



Mini evidenziatori colori pastello, **punta soft retinata** che ne garantisce durata e colore sempre vivace, 4 grammi d'inchiostro.
Confezione da 6 pezzi assortiti: arancio, rosa, verde, azzurro, giallo, lilla.

SPILLUMINA

PRISMA

Cod. 20060/015



1

U.M.V.



40

Imballo

Set da scrivania con **15 evidenziatori**: 9 colori fluorescenti e 6 colori pastello. Ampiezza tratto **1 - 5 mm**, inchiostro a base d'acqua, punta soft-tip morbida, **Anti-Dry-Out technology: evidenzia fino a 6 ore senza cappuccio.**



spillumina

DRILITE

Matita evidenziatore in **4 colori neon**. Legno certificato **FSC**. Fusto triangolare e **mina da 5 mm**. Blister da 4 pz colori assortiti, confezione da 12 blister.

Cod. 19537



12

U.M.V.



4

Imballo



FUSTO
TRIANGOLARE

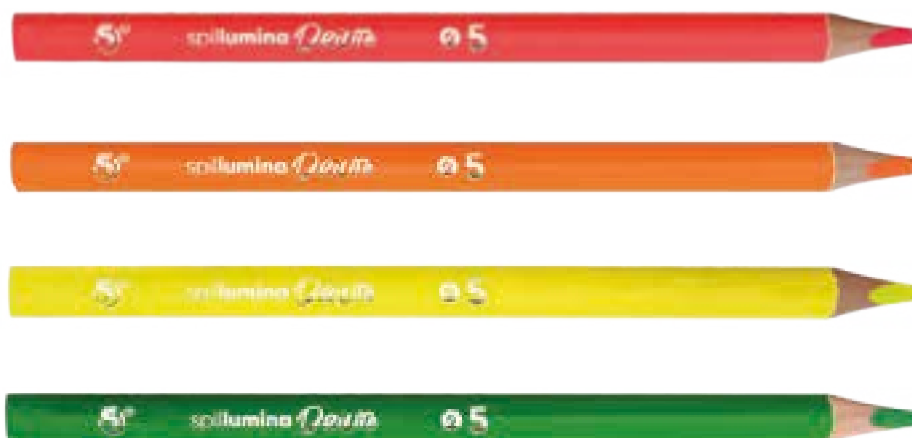

Ri-LUMINA

Neon

L'evidenziatore Ri-lumina ha una **doppia punta**, da un lato **scrive** e da un lato **cancella**. Confezione da 12 pezzi per colore singolo oppure blister da 6 pezzi assortiti: arancione, blu, giallo, rosa, verde, viola.

Cod. 20140/01

Cod. 20140/02

Cod. 20140/03

Cod. 20140/04

Cod. 20140/05

Cod. 20140/06

1
U.M.V.

12
Imballo

Cod. 20140/BL

1
U.M.V.

12
Imballo



Rosa

Viola

Blu

Verde

Giallo

Arancione



Ri-LUMINA PASTEL

L'evidenziatore Ri-lumina ha una **doppia punta**, da un lato **scrive** e da un lato **cancella**. Confezione da 12 pezzi per colore singolo oppure blister da 6 pezzi assortiti: arancione alba, blu cielo, giallo mimosa, rosa cipria, verde menta, glicine.

Cod. 20141/01

Cod. 20141/02

Cod. 20141/03

Cod. 20141/04

Cod. 20141/05

Cod. 20141/06

1
U.M.V.

12
Imballo

Cod. 20141/BL

1
U.M.V.

12
Imballo



Rosa cipria



Glicine



Blu cielo



Verde menta



Giallo mimosa



Arancione alba





SPiLeSSeNZA

EVIDENZIATORI PROFUMATI

Limone	
Patatine Fritte	
Melone	
Cioccolato a Menta	
Lampone	
Semifreddo alla Frutta	
Rosa	
Cupcake a Fragola	
Mango	
Arancia	
Crostata ai Mirtilli	
Vaniglia	

12 COLORI IN
12 PROFUMAZIONI!



PUNTO TRIANGOLARE



CODICE ARTICOLO : 22591/0144

Evidenzia al meglio!

L'evidenziatore è uno dei prodotti per l'ufficio e per la scuola più utilizzato. Utile per contrassegnare un documento o evidenziare qualcosa di importante. Gli evidenziatori Spil sono disponibili in colori fluo e pastel.

TANTO COLORE PER LO STUDIO E PER IL TUO LAVORO. SCEGLI TRA LE LINEE FLUO, PASTEL, ROUND, SOFT E GRIP, COLORI BRILLANTI DALLA PRIMA ALL'ULTIMA SOTTOLINEATURA.



Espositore vuoto, foto puramente indicativa.

Cod. 54731/24

 1
  1
  288

marki

universal S310

Marcatore **permanente punta tonda**. Scrive su qualsiasi superficie: carta, vetro, cartone, plastica, metallo e tessuto. Inchiostro ad asciugatura rapida.

Espositore da 36 pezzi: 18 nero, 6 blu, 6 verde, 6 rosso.

Confezione colore singolo da 12 pezzi.



PUNTA
TONDA

Tratto 1,9 mm

Cod. 22562/NR

Cod. 22562/BL

Cod. 22562/RS

Cod. 22562/VR



1
U.M.V.



72
Imballo

Cod. 22562/ESP



1
U.M.V.



12
Imballo



Espositore marki
universal S310



marki

universal S311

Marcatore **permanente punta a scalpello**. Scrive su qualsiasi superficie: carta, vetro, cartone, plastica, metallo e tessuto. Inchiostro ad asciugatura rapida.

Espositore da 36 pezzi: 18 nero, 6 blu, 6 rosso, 6 verde.

Confezione colore singolo da 12 pezzi.

Cod. 22563/NR

Cod. 22563/BL

Cod. 22563/RS

Cod. 22563/VR



1
U.M.V.



72
Imballo

Cod. 22563/ESP



1
U.M.V.



12
Imballo



PUNTA A
SCALPELLO

Tratto 2-4 mm



Espositore marki
universal S311



marki

whiteboard S312

Marcatore per lavagna bianca, lavagna a secco, vetro e superfici non porose. Inchiostro ad asciugatura rapida, **facile da cancellare**. Si rimuove senza lasciare tracce.

Espositore da 36 pezzi: 18 nero, 6 blu, 6 rosso, 6 verde.

Confezione colore singolo da 12 pezzi.



MARCATORE
CANCELLABILE



Espositore marki
whiteboard S312

Cod. 22564/NR

Cod. 22564/BL

Cod. 22564/RS

Cod. 22564/VR



1
U.M.V.



72
Imballo

Cod. 22564/ESP



1
U.M.V.



12
Imballo



PUNTA
FINE

Cod. 22565/NR

Cod. 22565/BL

Cod. 22565/RS



1
U.M.V.



144
Imballo

Cod. 22565/ESP



1
U.M.V.



12
Imballo

marki

permanent S313

Marcatore **permanente punta fine**. Scrive su qualsiasi superficie: carta, vetro, cartone, plastica, metallo e tessuto. Inchiostro ad asciugatura rapida. Espositore da 72 pezzi: 6 blu, 6 nero, 6 rosso, 9 verde, 9 giallo, 9 viola, 9 fucsia, 9 marrone, 9 arancio. Confezione colore singolo da 12 pezzi.



Espositore marki
permanent S313



S307
Punta S
(0,4 mm)



S308
Punta F
(0,6 mm)



S309
Punta M
(1,0 mm)

marki

universal OHP

Marcatore universale **permanente** per uso su carta, vetro, plastica e metallo. Nuova formula di inchiostro per una scrittura più scorrevole. Punta ideata per rilascio di inchiostro in modo continuo ed uniforme. Confezione colore singolo da 12 pezzi.

S

S307 - Punta S

Cod. 56143/NR

Cod. 56143/BL

Cod. 56143/RS



1

U.M.V.



72

Imballo

F

S308 - Punta F

Cod. 56144/NR

Cod. 56144/BL

Cod. 56144/RS



1

U.M.V.



72

Imballo

M

S309 - Punta M

Cod. 56145/NR

Cod. 56145/BL

Cod. 56145/RS



1

U.M.V.



72

Imballo



S21
Punta 0,2 mm



S21
Punta Pennello

S21 GRADUATED PEN

Penna **indelebile** per scrittura, disegno tecnico e schizzo. Confezione colore singolo da 12 pezzi.

Punta 0,05 mm

Cod. 56146/005NR

Punta 0,1 mm

Cod. 56146/01NR

Punta 0,2 mm

Cod. 56146/02NR

Cod. 56146/02BL

Cod. 56146/02RS

Punta 0,3 mm

Cod. 56146/03NR

Punta 0,4 mm

Cod. 56146/04NR

Punta 0,5 mm

Cod. 56146/05NR

Cod. 56146/05BL

Cod. 56146/05RS

Punta 0,8 mm

Cod. 56146/08NR

Punta Pennello

Cod. 56146/BR



1

U.M.V.



72

Imballo



I marcatori possono essere utilizzati per scrivere su tessuti, carta, cartone, plastica ed altri materiali. Sono utilizzati anche per progetti artistici e di design. La linea marcatori Spil è assortita per colori, forme e dimensioni. I marcatori sono disponibili con punta a scalpello, punta a pennello, punte di spessore variabile, sempre adatti ad ogni esigenza del consumatore.



Espositore vuoto, foto puramente indicativa.

Cod. 54731/21



1



1

252

Pezzi



DUETTO

Dual Tip Marker



GIALLO YELLOW 01	GIALLO NEON NEON YELLOW 02	GIALLO TUORLO YOLK YELLOW 03	MANDARINO MANDARIN 04	ARANCIO ORANGE 05	ARANCIO NEON NEON ORANGE 06
ALBICOCCA APRICOT 07	ROSA SAKURA SAKURA PINK 08	ROSA CHIARO LIGHT PINK 09	ROSA NEON NEON PINK 10	ROSA PINK 11	MALVA MAUVE 12
ROSSO RED 13	BORDEAUX BURGUNDY 14	LAVANDA LAVENDER 15	LILLA LILAC 16	VIOLETTA LIGHT VIOLET 17	VIOLA VIOLET 18
CIELO SKY BLUE 19	BLU CHIARO LIGHT BLUE 20	BLU BLUE 21	BLU COBALTO COBALT BLUE 22	VERDE MENTA MINT GREEN 23	TURCHESE TURQUOISE 24
VERDE ARTICO ARTIC GREEN 25	VERDE ACQUA TEAL 26	VERDE ERBA GRASS GREEN 27	VERDE PRATO LAWN GREEN 28	VERDE NEON NEON GREEN 29	VERDE SCURO DARK GREEN 30
VERDE OLIVA OLIVE GREEN 31	VERDE FORESTA FOREST GREEN 32	MARRONE BROWN 33	GRIGIO GRAY 34	NERO BLACK 35	BLENDER BLENDER 36

PENNARELLO BLENDER
(PER CREARE UN EFFETTO ACQUARELLATO)

DISPLAY DA
560 pezzi



CODICE ARTICOLO : 22592/0540

mino PERMANENT INK

DUAL TIP MARKER

Marcatore con inchiostro **permanente** a **doppia punta**: una **brush** e una **sottile**. Colori intensi e brillanti. Inchiostro ad asciugatura rapida. Confezione da 24 pezzi assortiti o da 24 pezzi per singolo colore. Espositore composto da 360 pezzi assortiti.



Cod. 20306/120	Cod. 20306/E37
Cod. 20306/CG5	Cod. 20306/V09
Cod. 20306/CG3	Cod. 20306/RV66
Cod. 20306/G29	Cod. 20306/V22
Cod. 20306/G28	Cod. 20306/R59
Cod. 20306/YG17	Cod. 20306/R29
Cod. 20306/YG06	Cod. 20306/R85
Cod. 20306/B28	Cod. 20306/R35
Cod. 20306/B06	Cod. 20306/YR68
Cod. 20306/BG07	Cod. 20306/YR65
Cod. 20306/BG05	Cod. 20306/Y08
Cod. 20306/E29	Cod. 20306/YR14

1 U.M.V.

24 Imballo

1 U.M.V.

12 Imballo

Cod. 20306/ASS



Espositore composto da 360 pezzi assortiti.

Cod. 20306/ESP

1 U.M.V.

12 Imballo

binò PERMANENT INK

DUAL TIP MARKER

Marcatore **permanente** a **doppia punta**: una **piatta** e una **sottile**. Scrive su qualsiasi superficie, colori intensi e brillanti, inchiostro ad asciugatura rapida. Confezione da 24 pezzi assortiti o da 24 pezzi per singolo colore. Espositore da 360 pezzi assortiti.



- | | |
|----------------------|-----------------|
| Cod. 22567/120 | Cod. 22567/E37 |
| Cod. 22567/CG5 | Cod. 22567/V09 |
| Cod. 22567/CG3 | Cod. 22567/RV66 |
| Cod. 22567/G29 | Cod. 22567/V22 |
| Cod. 22567/G28 | Cod. 22567/R59 |
| Cod. 22567/YG17 | Cod. 22567/R29 |
| Cod. 22567/YG06 | Cod. 22567/R85 |
| Cod. 22567/B28 | Cod. 22567/R35 |
| Cod. 22567/B06 | Cod. 22567/YR68 |
| Cod. 22567/BG07 | Cod. 22567/YR65 |
| Cod. 22567/BG05 | Cod. 22567/Y08 |
| Cod. 22567/E29 | Cod. 22567/YR14 |
| Cod. 22567/24 | |

1 U.M.V.

24 Imballo

1 U.M.V.

12 Imballo



Espositore composto da 360 pezzi assortiti.

Cod. 22567/ESP

1 U.M.V.

1 Imballo



S17

Correttore 2 in 1, **puntale in metallo** e **pennello interno**. Contiene **17 ml** di prodotto. Confezione 12 pezzi.



PUNTALE IN METALLO



PENNELLO INTERNO

Cod. 28182



1

U.M.V.



48

Imballo

17
ML



S13 CANDY

Correttore a penna, **13 ml**, **puntale in metallo**, grip ergonomico, 4 colori pastello. Confezione 48 pezzi assortiti.



PUNTALE IN METALLO

Cod. 28181/48C



1

U.M.V.



12

Imballo

13
ML



S13 BRILLO

Correttore a penna, **13 ml**, **puntale in metallo**, grip ergonomico, 4 colori fluorescenti. Confezione 48 pezzi assortiti.



PUNTALE IN METALLO

Cod. 28181/48B



1

U.M.V.



12

Imballo

13
ML



S13

Correttore a penna, **13 ml**, **puntale in metallo**, grip ergonomico. Confezione 24 pezzi assortiti.



PUNTALE IN METALLO

Cod. 28181/24



1

U.M.V.



24

Imballo

13
ML



Correttore a nastro **4.2 mm x 8 mt.**
 Confezione 24 pezzi in 4 colori assortiti.

Cod. 01671

1 U.M.V. 30 Imballo

METRI 8



S38 INFINITY

Correttore a nastro, **5 mm x 38 mt.** Corpo traslucido,
 confezione da 12 pezzi in tre colori, blisterati
 singolarmente.

Cod. 11848

1 U.M.V. 24 Imballo

METRI 38



S12

Correttore a nastro **5 mm x 12 mt.**
 Confezione 12 pezzi, blisterati singolarmente.

Cod. 23649

1 U.M.V. 48 Imballo

METRI 12



Tutti i colori pi Spi!



Disegno

COLORI	38
MATITE	47
TEMPERAMATITE	50
GOMME	53
BLOCCHI DISEGNO	56
SQUADRE-RIGHE	58
COMPASSI	64
FORBICINE	74
CARTELLE PORTA DISEGNI	76



tinted pigmento

Fusto esagonale e mina da **04mm**.
Confezione da 12, 18, 24 e 36 colori.

Cod. 19380/SC12

1 Imballo
U.M.V. 12

Cod. 19380/SC24

1 Imballo
U.M.V. 6



Cod. 19380/SC18

1 Imballo
U.M.V. 8

Cod. 19380/SC36

1 Imballo
U.M.V. 4



tinted pigmento Big

Fusto esagonale e mina da **06mm**.
Confezione da 12 colori.



Cod. 20008/SC12

6 Imballo
U.M.V. 120



tinted

PIGMENTO

Pastelli a colori, mina da **04 mm** di altissima qualità per una colorazione brillante. Facili da temperare. Confezione da 24 pezzi per singolo colore.



1
U.M.V.

12
Imballo

Tinted Pigmento: dove la creatività incontra il colore

LASCIATI INEBRIARE DALLA CREATIVITÀ, CON I NOSTRI COLORI POTRAI DARE LIBERO SFOGO AI TUOI PENSIERI ED ALLA TUA ARTE, SENZA LIMITI. AVRAI A DISPOSIZIONE TUTTI I COLORI DI CUI NECESSITI, DALLE TINTE PIÙ CLASSICHE A QUELLE PIÙ RICERCATE.



Cod. 58182/ESP

1 U.M.V. 1 Imballo 396 Pezzi

Assortimento composto da:

ASTUCCIO PIGMENTO DA 12	24 CONF.	COLORI SINGOLI PIGMENTO	432 PZ.
ASTUCCIO PIGMENTO DA 18	16 CONF.	ASTUCCIO PIGMENTO BIG DA 12	12 CONF.
ASTUCCIO PIGMENTO DA 24	12 CONF.	TEMPERINO TRE FORI S107	12 PZ.
ASTUCCIO PIGMENTO DA 36	12 CONF.	ESPOSITORE DA BANCO	1 PZ.



CoLoR Sticks

Tempera solida in tubetti da **10 gr.**
 Colori brillanti ad ottima copertura e lavabili. **Prodotto atossico.**
 Disponibile in confezione da 6 e 12 pezzi, colori assortiti, vetrinetta da 96 pezzi (8 pezzi per colore).

Cod. 14593/6

12 U.M.V. 48 Imballo

Cod. 14593/12

12 U.M.V. 24 Imballo

Cod. 14593/96

1 U.M.V. 4 Imballo



BRUCCO

PENNARELLI LAVABILI

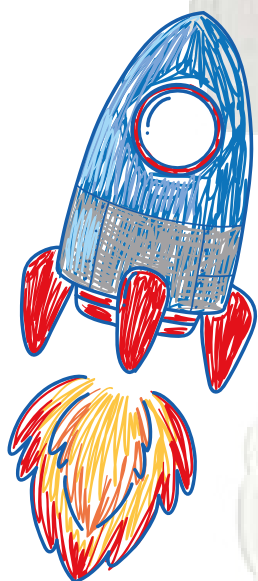

SCATOLA DA 36 PEZZI
IN PPL INFRANGIBILE



CODICE ARTICOLO: 23025/36



PUNTA 2.8 MM

INCHIOSTRO LAVABILE
A BASE D'ACQUA

binò
DUAL TIP MARKER PERMANENT INK

Marcatore **permanente** a **doppia punta**: una **piatta** e una **sottile**. Scrive su qualsiasi superficie, colori intensi e brillanti, inchiostro ad asciugatura rapida. Confezione da 24 pezzi assortiti o da 24 pezzi per singolo colore. Espositore da 360 pezzi assortiti.



- | | |
|-----------------|-----------------|
| Cod. 22567/120 | Cod. 22567/E37 |
| Cod. 22567/CG5 | Cod. 22567/V09 |
| Cod. 22567/CG3 | Cod. 22567/RV66 |
| Cod. 22567/G29 | Cod. 22567/V22 |
| Cod. 22567/G28 | Cod. 22567/R59 |
| Cod. 22567/YG17 | Cod. 22567/R29 |
| Cod. 22567/YG06 | Cod. 22567/R85 |
| Cod. 22567/B28 | Cod. 22567/R35 |
| Cod. 22567/B06 | Cod. 22567/YR68 |
| Cod. 22567/BG07 | Cod. 22567/YR65 |
| Cod. 22567/BG05 | Cod. 22567/Y08 |
| Cod. 22567/E29 | Cod. 22567/YR14 |

1 U.M.V.

24 Imballo

1 U.M.V.

12 Imballo

Cod. 22567/24



Espositore composto da 360 pezzi assortiti.

Cod. 22567/ESP

1 U.M.V.

1 Imballo

binò PERMANENT INK

DUAL TIP MARKER

Marcatore con inchiostro **permanente** a **doppia punta**: una **brush** e una **sottile**. Colori intensi e brillanti. Inchiostro ad asciugatura rapida. Confezione da 24 pezzi assortiti o da 24 pezzi per singolo colore. Espositore composto da 360 pezzi assortiti.





- | | |
|-----------------|-----------------|
| Cod. 20306/120 | Cod. 20306/E37 |
| Cod. 20306/CG5 | Cod. 20306/V09 |
| Cod. 20306/CG3 | Cod. 20306/RV66 |
| Cod. 20306/G29 | Cod. 20306/V22 |
| Cod. 20306/G28 | Cod. 20306/R59 |
| Cod. 20306/YG17 | Cod. 20306/R29 |
| Cod. 20306/YG06 | Cod. 20306/R85 |
| Cod. 20306/B28 | Cod. 20306/R35 |
| Cod. 20306/B06 | Cod. 20306/YR68 |
| Cod. 20306/BG07 | Cod. 20306/YR65 |
| Cod. 20306/BG05 | Cod. 20306/Y08 |
| Cod. 20306/E29 | Cod. 20306/YR14 |
| Cod. 20306/ASS | |

 1 U.M.V.	 24 Imballo	 1 U.M.V.	 12 Imballo
--	---	--	--



Espositore composto da 360 pezzi assortiti.

Cod. 20306/ESP	
 1 U.M.V.	 12 Imballo

ZERO4

FINELINER 0.4

Penna con **punta fina 0.4 mm**, ideale per la scrittura e il disegno, asciugatura rapida, sistema di rilascio fluido dell'inchiostro per una scrittura perfetta.



- | | |
|----------------------|----------------------|
| Cod. 22568/01 | Cod. 22568/11 |
| Cod. 22568/02 | Cod. 22568/12 |
| Cod. 22568/03 | Cod. 22568/13 |
| Cod. 22568/04 | Cod. 22568/14 |
| Cod. 22568/05 | Cod. 22568/15 |
| Cod. 22568/06 | Cod. 22568/16 |
| Cod. 22568/07 | Cod. 22568/17 |
| Cod. 22568/08 | Cod. 22568/18 |
| Cod. 22568/09 | Cod. 22568/19 |
| Cod. 22568/10 | Cod. 22568/20 |

1 U.M.V.
 12 Imballo
 12 Pezzi



Espositore penne con **punta fina 0.4 mm**, 360 pezzi assortiti.

Cod. 22568/ESP

1 U.M.V.
 1 Imballo





MATI' S201

Cod. 11850/2H

Cod. 11850/H

Cod. 11850/HB

Cod. 11850/B

Cod. 11850/2B

Matita in legno **certificato FSC** e mina da **ø2.2mm**, disponibile in 5 gradazioni.

Confezione da 12 matite per singola gradazione, espositore da 144 pezzi assortiti:

48 HB, 24 2H, 24 H, 24 B, 24 2B.

Gradazione facilmente identificabile per la diversa colorazione del terminale del fusto.



Cod. 11850/ESP

1 U.M.V.

240 Imballo

1 U.M.V.

4 Imballo



matite HELLO SKETCH

Matita in legno **certificato FSC** e mina da **ø2.2 mm**. Fusto triangolare in 6 colori fluorescenti con gommino in tinta. Confezione da 48 pezzi.

Cod. 14614

1
U.M.V.

48
Imballo



SKETCHY

Porta micromina, punta in metallo rientrabile da **ø0.5 - ø0.7mm**, cursore per evidenziare la gradazione, gomma integrata e protetta.

Confezione 24 pezzi, espositore composto da 24 pezzi: 12 per modello.

Cod. 23705/ESP

1
U.M.V.

24
Imballo



CURSORE DI GRADAZIONE



PUNTA RIENTRABILE



Espositore **SKETCHY**

tinted **RE** PASTELLO BICOLORE

Pastello bicolore rosso e blu, fusto esagonale e mina **ø4mm**.
 Confezione da 12 pezzi.

Cod. 19543/M

1
U.M.V.

12
Imballo



tinted **RE** Jumbo PASTELLO BICOLORE

Pastello bicolore rosso e blu, fusto esagonale e mina **ø5mm**.
 Confezione da 12 pezzi.

Cod. 19549/J

1
U.M.V.

12
Imballo





TEMPERAMATITE S105

Cod. 05965

In metallo, **1 foro**, per matite grafite e colorate.
Confezione da 24 pezzi.



TEMPERAMATITE S104

In metallo, **2 fori**, per matite grafite e colorate.
Confezione da 12 pezzi.

Cod. 05967



TEMPERAMATITE S101

In metallo, 2 fori, con serbatoio, tappo di chiusura trasparente. Confezione da 24 pezzi assortiti in colori brillo o candy.

BRILLO

CANDY

Cod. 05994/01

Cod. 05994/02



1 U.M.V. 24 Imballo

1 U.M.V. 24 Imballo



TEMPERAMATITE S102

In metallo, 2 fori, con serbatoio. Confezione da 24 pezzi assortiti in colori brillo e candy.

BRILLO

CANDY

Cod. 05998/01

Cod. 05998/02



1 U.M.V. 24 Imballo

1 U.M.V. 24 Imballo



TEMPERAMATITE S106

In metallo, 2 fori, con serbatoio, tappo di chiusura trasparente.
Confezione da 24 pezzi assortiti.

Cod. 14718



1
U.M.V.

240
Imballo



TEMPERAMATITE S107

In plastica, 3 fori, con serbatoio.
Confezione da 12 pezzi assortiti.
Ideale per temperare matite di ogni dimensione.
Ottimo per temperare matite cosmetiche e da tenere in borsetta.

Cod. 14719



1
U.M.V.

120
Imballo



DELEO S404

Prodotto **senza PVC** e lattice. Espositore da 20 pezzi. Formato 60 x 20 x 12 mm.

Fascetta scorrevole per un uso funzionale.

BRILLO

Cod. 57688/B



1 U.M.V.

30 Imballo

CANDY

Cod. 57688/C



1 U.M.V.

30 Imballo



DELEO S402

Gomma per cancellare, formato 60 x 20 x 12 mm.

Espositore da 20 pezzi. Prodotto **senza PVC**.

Fascetta scorrevole per un uso funzionale.

Cod. 11858



1 U.M.V.

30 Imballo



DELEO S404 premium

Gomma bianca per cancellare. Prodotto **senza PVC** e lattice. Espositore da 20 pezzi.
Formato 60 x 20 x 12 mm.
Fascetta scorrevole per un uso funzionale.

Cod. 11860



DELEO S403

Gomma pane morbida per correggere e schiarire. Espositore da 18 pezzi.

Cod. 11859





DELEO S405

• kliker •

Gomma **a scatto** per cancellare, prodotto **senza PVC e lattice**. Ricaricabile con refill. Espositore da 24 pezzi.

Cod. 55407/1

1
U.M.V.

24
Imballo



DELEO S505

• kliker refill •

Cod. 55407/2

1
U.M.V.

24
Imballo

Refill per S405 KLIKER. Prodotto **senza PVC e lattice**. Confezione da 12 pezzi.

S

BLOCCO DUE PER LA SCUOLA

Blocco disegno: carta **120 g/m²**, superficie ruvida e liscia, ruvida per grafite morbida, carboncino e pastello. Liscia per matita, pennarello, china e cera.



FOGLI
22

Cod.	Modello	Formato	Grammatura
Cod. 28177/LI	Liscio	24x33	120
Cod. 28177/RI	Riquadrato	24x33	120
Cod. 28177/RU	Ruvido	24x33	120

10
U.M.V.

60
Imballo

FOGLI
14

Cod.	Modello	Formato	Grammatura
Cod. 28178/LI	Liscio	33x48	120
Cod. 28178/RI	Riquadrato	33x48	120
Cod. 28178/RU	Ruvido	33x48	120

10
U.M.V.

40
Imballo

S

BLOCCO QUATTRO PER LA SCUOLA

Blocco disegno: carta **220 g/m²** per superficie liscia e riquadrata, carta **200 g/m²** per superficie ruvida. Particolarmente indicato per studenti di istituti tecnici e per l'uso professionale di grafici, architetti, geometri.



FOGLI
22

Cod.	Modello	Formato	Grammatura
Cod. 28175/LI	Liscio	24x33	220
Cod. 28175/RI	Riquadrato	24x33	220
Cod. 28175/RU	Ruvido	24x33	200

10
U.M.V.

40
Imballo

FOGLI
22

Cod.	Modello	Formato	Grammatura
Cod. 28176/LI	Liscio	33x48	220
Cod. 28176/RI	Riquadrato	33x48	220
Cod. 28176/RU	Ruvido	33x48	200

10
U.M.V.

20
Imballo

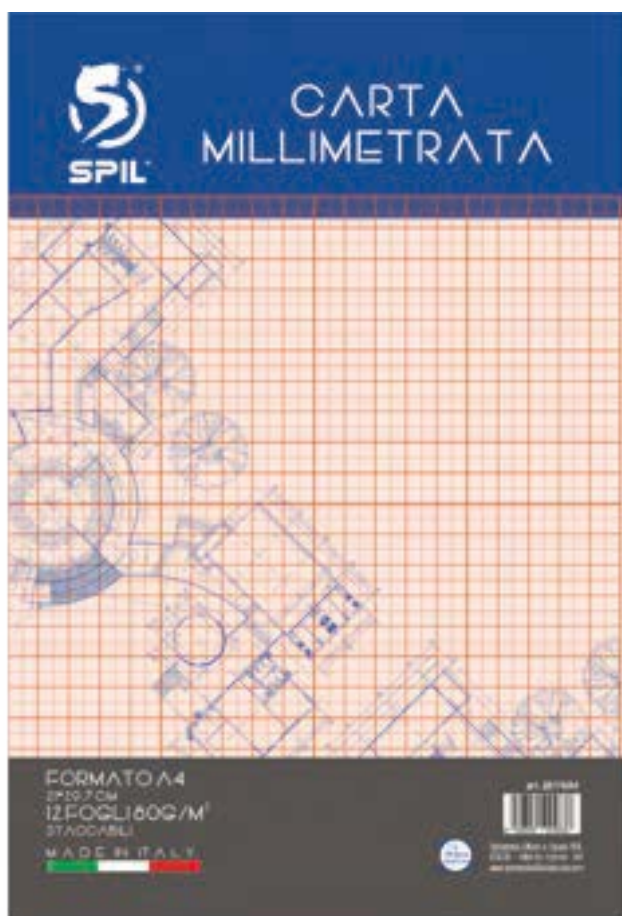

CARTA MILLIMETRATA

Blocco carta millimetrata liscia per disegno tecnico contenente **12 fogli** da **80 g/m²**.

Cod. 28174/A4

Cod. 28174/A3

FOGLI
12

25
U.M.V.

200
Imballo

25
U.M.V.

100
Imballo

CARTA LUCIDA

Blocco carta lucida satinata per disegno tecnico contenente **12 fogli** da **72 g/m²**.

Cod. 28179/A4

Cod. 28179/A3

FOGLI
12

25
U.M.V.

250
Imballo

25
U.M.V.

100
Imballo





tekno[®]
Made in Italy SPIL[®]

RIGHELLO "TEKNO"

Realizzato in plastica colorata
traslucida, L. 16 cm. Confezione da
40 pezzi in 4 colori assortiti.



Cod. 00955

1
U.M.V.

4
Imballo

16
CM



15
CM



RIGHELLO "TEKNO"

In **alluminio**, L. 15 cm, con bordo tirachina.
Confezione barattolo da 15 pezzi.

Cod. 11607

1
U.M.V.

5
Imballo

40
CM



50
CM



60
CM



RIGA "TEKNO"

In plastica traslucida di colore azzurro, **flessibile ed indeformabile**. Gradazione millimetrata ad incisione chimica con profilo tirachina. Confezione da 20 pezzi in astuccio appendibile.

Cod. 00934/40

Cod. 00934/50

Cod. 00934/60

1
U.M.V.

200
Imballo

20
CM



Cod. 00941

30
CM



Cod. 00946

Cod. 00941

Cod. 00946

20
U.M.V.

200
Imballo

DECIMETRO "TEKNO"

In plastica traslucida di colore azzurro, **flessibile ed indeformabile**. Gradazione millimetrata ad incisione chimica con profilo tirachina. Confezione da 20 pezzi in astuccio appendibile.

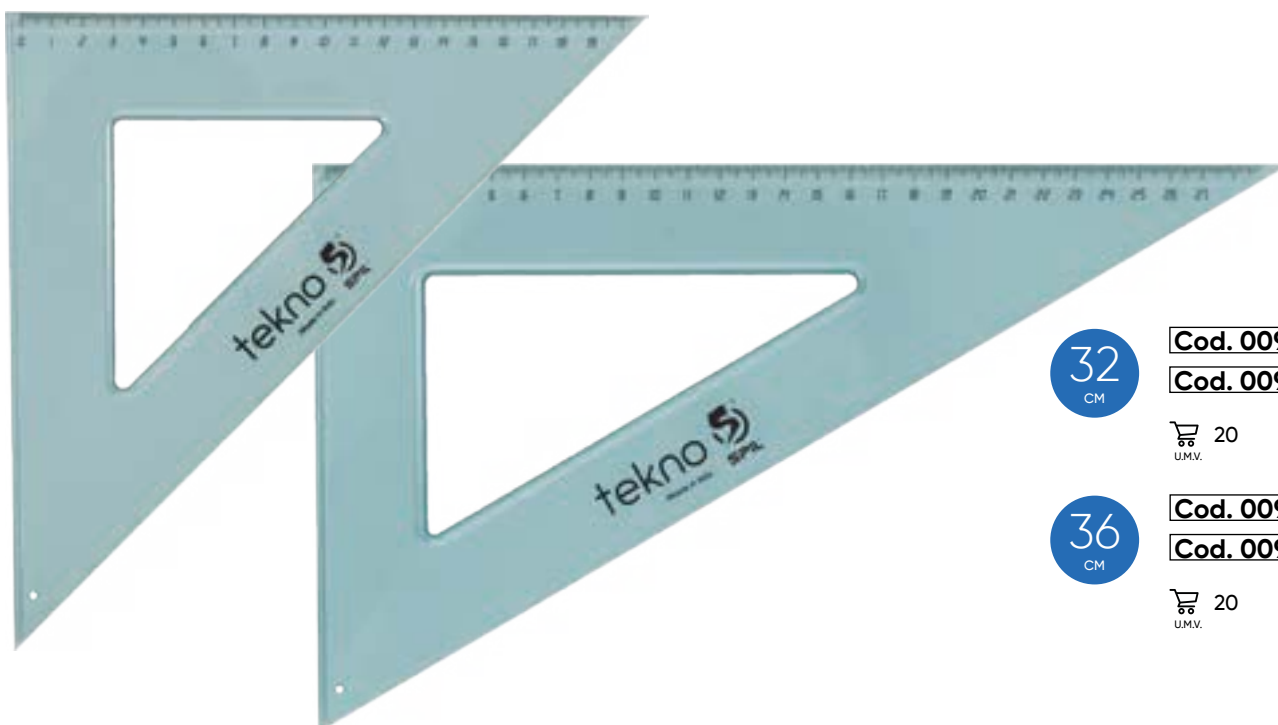

32
CM

Cod. 00937/45

Cod. 00937/60

20
U.M.V.

200
Imballo

36
CM

Cod. 00938/45

Cod. 00938/60

20
U.M.V.

200
Imballo

SQUADRA "TEKNO"

In plastica traslucida di colore azzurro, **flessibile ed indeformabile**. Gradazione millimetrata ad incisione chimica con profilo tirachina. Confezione da 20 pezzi in astuccio appendibile.

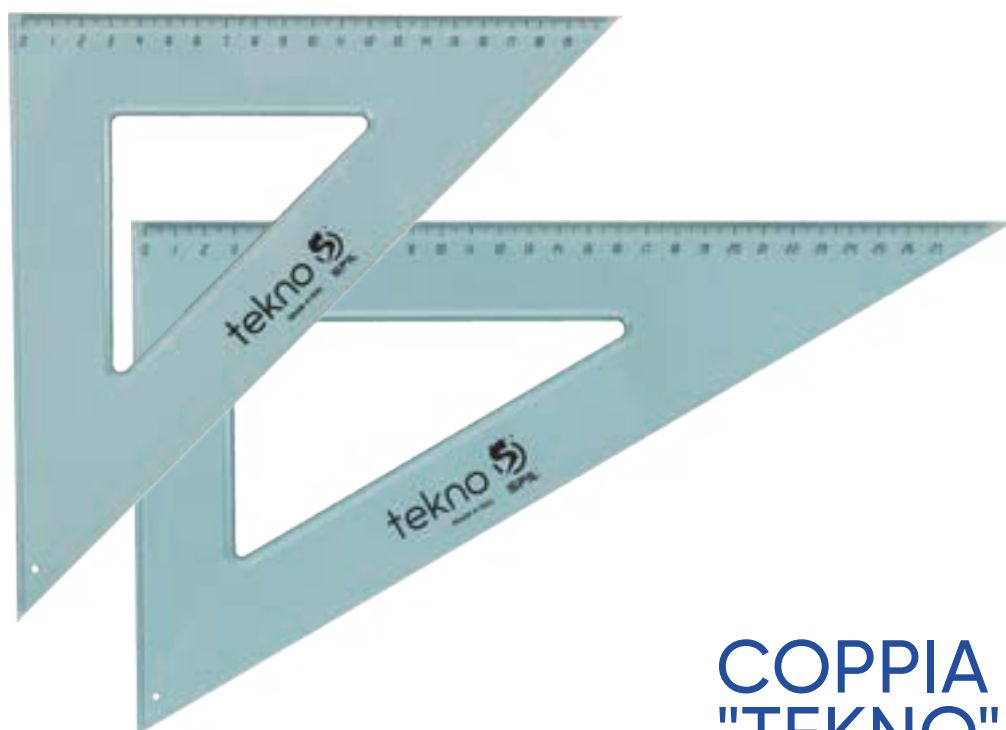

16
CM

Cod. 00948/16

20
U.M.V.

200
Imballo

32
CM

Cod. 00948/32

20
U.M.V.

200
Imballo

36
CM

Cod. 00948/36

20
U.M.V.

200
Imballo

COPPIA SQUADRE "TEKNO"

In plastica traslucida di colore azzurro, **flessibili ed indeformabili**. Gradazione millimetrata ad incisione chimica con profilo tirachina. Confezione da 20 pezzi in astuccio appendibile.

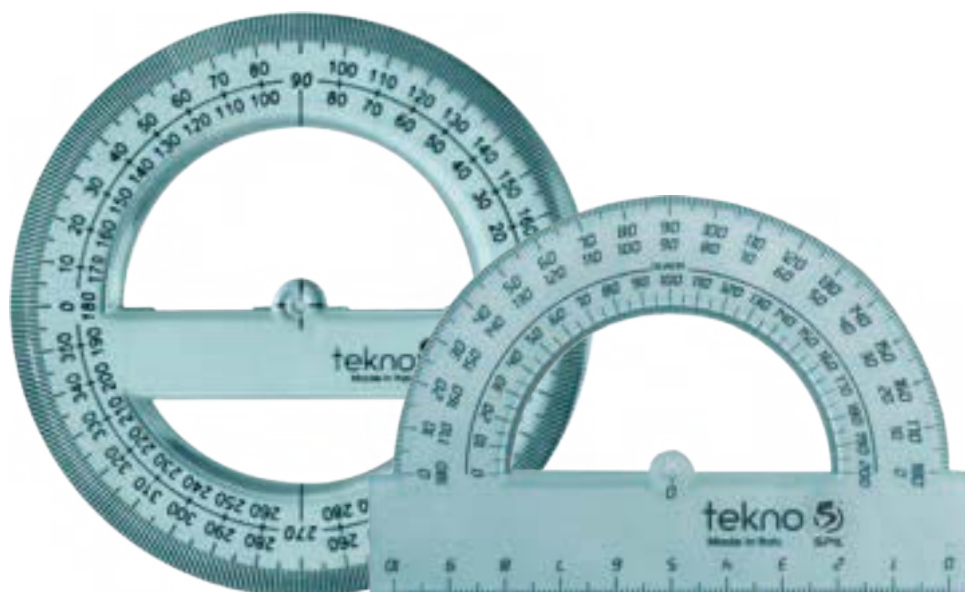

GONIOMETRI "TEKNO"

In plastica traslucida di colore azzurro, **flessibile ed indeformabile**. Gradazione millimetrata ad incisione chimica con profilo tirachina. Confezione da 20 pezzi in astuccio appendibile.

180
GRADI

Cod. 00947/180

1
U.M.V.

100
Imballo

360
GRADI

Cod. 00947/360

1
U.M.V.

100
Imballo

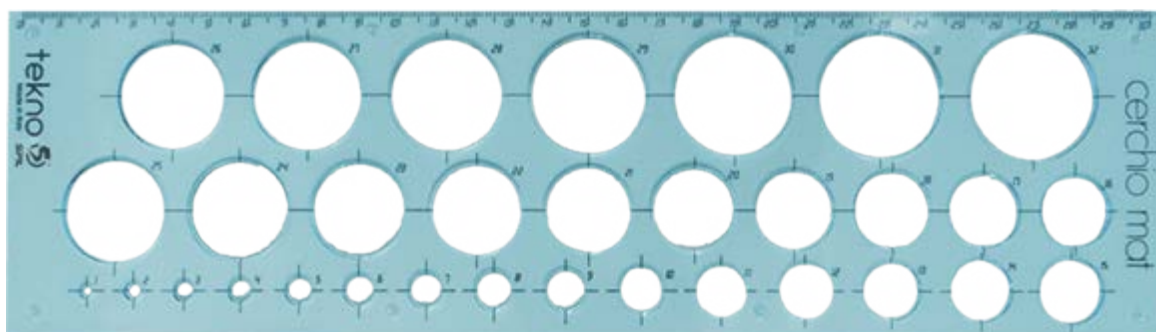

CERCHIOMETRO 1-35 "TEKNO"

In plastica **traslucida** di colore azzurro. Confezione 20 pezzi in astuccio appendibile.

Cod. 00953

1
U.M.V.

200
Imballo



SET 3 CURVILINEE "TEKNO"

In plastica **traslucida** di colore azzurro, 3 modelli, con doppia tiralinea.

Cod. 00950

20
U.M.V.

100
Imballo



ESPOSITORE TEKNO



Cod. 54817/ESP



Espositore composto da:

RIGA 50 CM	20 PZ	DOPPIO DECIMETRO	20 PZ
RIGA 60 CM	20 PZ	TRIPLO DECIMETRO	20 PZ
SQUADRA 32 CM/45°	20 PZ	GONIOMETRO 180°	20 PZ
SQUADRA 32 CM/60°	20 PZ	GONIOMETRO 360°	20 PZ
SQUADRA 36 CM/45°	20 PZ	COPPIA SQUADRE 16 CM	20 PZ
SQUADRA 36 CM/60°	20 PZ	ESPOSITORE DA BANCO IN CARTONE	1 PZ



COMPASSO

Aste fisse, mine supplementari, confezione in astuccio appendibile.

Cod. 04728

 5
U.M.V.

 20
Imballo



COMPASSO

Set da **3 pezzi** in astuccio appendibile: compasso, innesto universale, mine supplementari.

Cod. 04729

 5
U.M.V.

 20
Imballo





COMPASSO

Set da **5 pezzi** in astuccio appendibile:
 compasso, innesto a punta, tiralinee,
 manichetto, mine supplementari.

Cod. 15182

5
U.M.V.

20
Imballo



COMPASSO

Set da **7 pezzi**:
 compasso, balaustrino, manichetto, innesto
 a punta, tiralinee, tiralinee con manico,
 mine supplementari. Confezione in astuccio
 appendibile.

Cod. 15183

5
U.M.V.

20
Imballo



BALAUSTRINO

Aste fisse, apertura rapida, regolazione micrometrica, mine supplementari.
 Confezione in astuccio appendibile.

Cod. 12382

 5
 U.M.V.

 20
 Imballo



BALAUSTRONE CLASSICO

Aste fisse, mine di ricambio, confezione in astuccio appendibile.

Cod. 04725/01

 5
 U.M.V.

 20
 Imballo



BALAUSTRONE CANDY

Aste fisse, mine di ricambio, confezione in astuccio appendibile in plastica infrangibile, disponibile in **5 colori pastello**.

Cod. 04725/02



5
U.M.V.

20
Imballo



BALAUSTRONE BRILLO

Aste fisse, mine supplementari, confezione in astuccio appendibile in plastica infrangibile. Disponibile in **5 colori fluorescenti**.

Cod. 04725/05



5
U.M.V.

20
Imballo



BALAUSTRONE "TOUCH"

Aste fisse, mine supplementari, confezione in astuccio appendibile. Disponibile con aste **soft touch in 4 colori**.

Cod. 15184



5 U.M.V.

20 Imballo



BALAUSTRONE "METAL"

Aste fisse, mine supplementari, confezione in astuccio appendibile. Disponibile in **3 colori metallizzati**.

Cod. 04725/03



5 U.M.V.

20 Imballo



BALAUSTRONE "ALLBLACK"

Aste fisse, mine supplementari, confezione in astuccio appendibile. Aste ed impugnatura total black.

Cod. 04725/04

5 U.M.V.

20 Imballo



Per un cerchio perfetto,
scegli i compassi Spil!



BALAUSTRONE BRILLO

Con **frizione**, **aste articolate**, attacco per graphos e mine supplementari, confezione in astuccio appendibile. **4 colori fluorescenti**.

Cod. 04748/02



 5
U.M.V.

 20
Imballo



BALAUSTRONE CLASSICO

Con **frizione**, **aste pieghevoli**, attacco per graphos, mine supplementari, confezione in astuccio appendibile.

Cod. 04748/01

 5
U.M.V.

 20
Imballo



BALAUSTRONE CLASSICO

Con **frizione, aste articolate, prolunga**, attacco per graphos, mine supplementari, confezione in astuccio appendibile.

Cod. 04750/01

5 U.M.V. 20 Imballo



BALAUSTRONE BRILLO

Con **frizione, aste articolate, prolunga**, attacco per graphos, mine di ricambio, in astuccio appendibile. Disponibile in **4 colori fluorescenti**.

Cod. 04750/02



5 U.M.V. 20 Imballo



MINE DI RICAMBIO

Confezione N. 15
astucci contenenti
ognuno **10 mine**
supplementari.

Cod. 54465

 1 U.M.V.
  5 Imballo
  15 Pezzi



SET MINUTERIA

Confezione da N. 15 pezzi contenenti ognuno **5 pezzi** di ricambio per compassi.

Cod. 54466

 1 U.M.V.
  5 Imballo
  15 Pezzi







TAGLIACCIOI

FORBICI con BASE

Forbici con base, L. 13 cm, punta arrotondata, impugnatura modellata. Espositore da 12 pezzi (4 per soggetto).

Cod. 21504/01

Cod. 21504/02

Cod. 21504/03



1

U.M.V.



4

Imballo



1

U.M.V.



4

Imballo



1

U.M.V.



4

Imballo



ANIMALI

Forbici fantasia animali, L. 13,5 cm, punta arrotondata. Espositore da 32 pezzi (8 per soggetto).

Cod. 55256



1

U.M.V.



4

Imballo



TAGLIA & RITAGLIA

Forbici, L. 13 cm, punta arrotondata, impugnatura modellata. Espositore da 30 pezzi assortiti.

Cod. 14466



1

U.M.V.



4

Imballo





LEFTI

Forbici centimetrare per mancini, **L. 13,5 cm**, punta arrotondata. Espositore da **30 pezzi**.

Cod. 19149

1
U.M.V.

4
Imballo



CENTIMETRARE

Forbici centimetrare, **L. 13,5 cm**, punta arrotondata. Espositore da **30 pezzi** assortiti.

Cod. 15197

1
U.M.V.

4
Imballo



RETURN

Forbici centimetrare, **L. 13,5 cm**, punta arrotondata, meccanismo di riapertura automatico. Espositore da **30 pezzi** assortiti.

Cod. 15198

1
U.M.V.

4
Imballo



VALIGETTA IN PP ALVEOLARE COLORATA

500 micron, con **2 chiusure**, colori assortiti. Ogni valigetta é **montata e blisterata** singolarmente in film termoretraibile.

Cod. 02913/27385

Formato: 27 x 38 x 5
Chiusure: 2



Cod. 02913/38534

Formato: 38 x 53 x 4,5
Chiusure: 2



Cod. 02913/27388

Formato: 27 x 38 x 8
Chiusure: 2



Cod. 02913/38536

Formato: 38 x 53 x 6
Chiusure: 2



VALIGETTA IN PP ALVEOLARE NEUTRA

500 micron, con **2 chiusure**. Ogni valigetta é **montata e blisterata** singolarmente in film termoretraibile.



Cod. 05751/27383

Formato: 27 x 38 x 3
Chiusure: 1



Cod. 05751/38534

Formato: 38 x 53 x 4,5
Chiusure: 2



Cod. 05751/27385

Formato: 27 x 38 x 5
Chiusure: 2



Cod. 05751/38536

Formato: 38 x 53 x 6
Chiusure: 2



Cod. 05751/27388

Formato: 27 x 38 x 8
Chiusure: 2



Cod. 05751/52724

Formato: 52 x 72 x 4
Chiusure: 2



Cod. 05751/751054

Formato: 75 x 105 x 4,5
Chiusure: 2



VALIGETTA IN PP ALVEOLARE "PASTELLO"

500 micron, con **2 chiusure**, colori pastello. Ogni valigetta é **montata e blisterata** singolarmente in film termoretraibile.

Cod. 54329/27385
Formato: 27 x 38 x 5
Chiusure: 2



Cod. 54329/38534
Formato: 38 x 53 x 4
Chiusure: 2



Cod. 54329/27388
Formato: 27 x 38 x 8
Chiusure: 2



Cod. 54329/38536
Formato: 38 x 53 x 6
Chiusure: 2



VALIGETTA IN PP RIGIDO "FLUO"

500 micron, **2 chiusure** ad incastro, colori fluo.



Cod. 20200
Formato: 38 x 27 x 5
Chiusure: 1



Cod. 20202
Formato: 52 x 38 x 6
Chiusure: 2



Cod. 20201
Formato: 38 x 27 x 8
Chiusure: 1



VALIGETTA SOFT IN PP

Formato 27 x 38 x 3,5 cm, a **soffietto**, colori fluorescenti o pastello assortiti.



CANDY

Cod. 57689/27355C

Formato: 38 x 27 x 3,5

Chiusure: 1



U.M.V.



Imballo



BRILLO

Cod. 57689/27355B

Formato: 38 x 27 x 3,5

Chiusure: 1



U.M.V.



Imballo

VALIGETTA SOFT IN PP

Formato 37 x 52 x 3 cm a **soffietto**, con **tracolla**, colori fluorescenti o pastello assortiti.



CANDY

Cod. 57689/37523C

Formato: 37 x 52 x 3

Chiusure: 2



U.M.V.

Imballo



BRILLO

Cod. 57689/37523B

Formato: 37 x 52 x 3

Chiusure: 2



U.M.V.

Imballo

Quaderni fatti per creare!

TUNITED **XXL**

CARTOTECNICA

MAXI QUADERNO MONOCOLORE.....	84
MAXI QUADERNO CARTONATO	89
QUADERNI A5	89
RUBRICHE	90
RICAMBI	91
MAXI QUADERNO MUSICA.....	92
QUADERNI LABORATORIO	93
CARTA PROTOCOLLO	94
SPILNOTES	95
PORTA BLOCCHI	98

LEGENDA

DICITURE:

NEON = COPERTINA DAI COLORI FLUORESCENTI
PASTEL = COPERTINA DAI COLORI PASTELLO
PPL = POLIPROPILENE

FORMATI:

A3 = 29,7*42 CM
A4 = 21*29,7 CM
A5 = 14,8*21 CM

RIGATURE QUADERNI:

RIGATURA A:

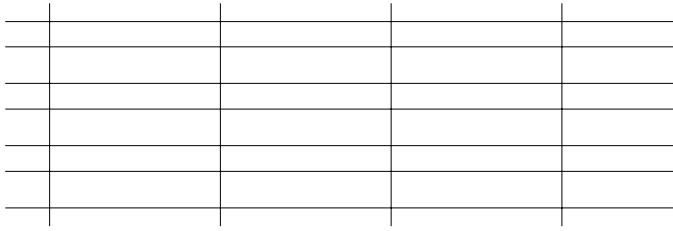

RIGATURA B:

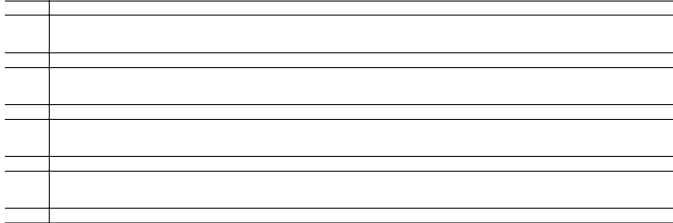

RIGATURA QUADERNI C - MAXI QUADERNI 1 RC:



RIGATURA 1 R



RIGATURA QUADERNI 7 - MAXI QUADERNI 4 MM:

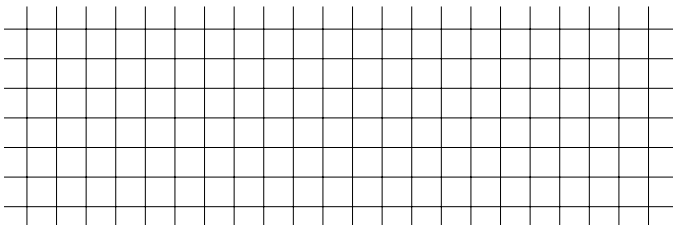

RIGATURA 4 F

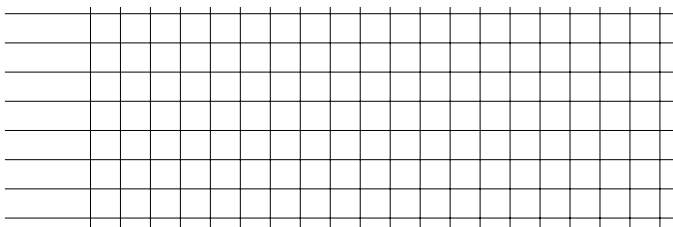

RIGATURA UB



RIGATURA 5 MM:

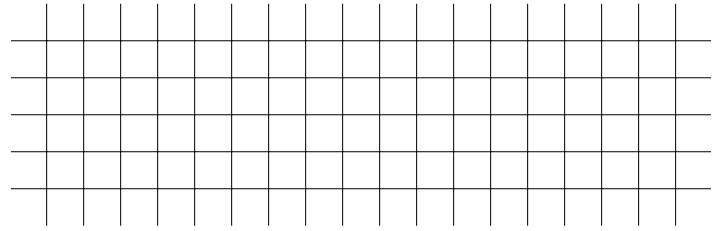

RIGATURA 10 MM:

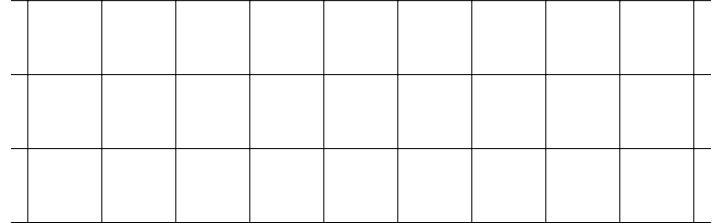

RIGATURA Q:

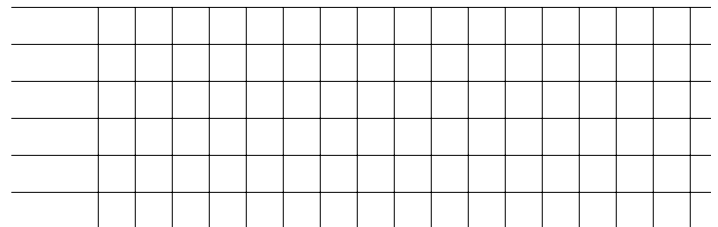

RIGATURA COMMERCIALE:

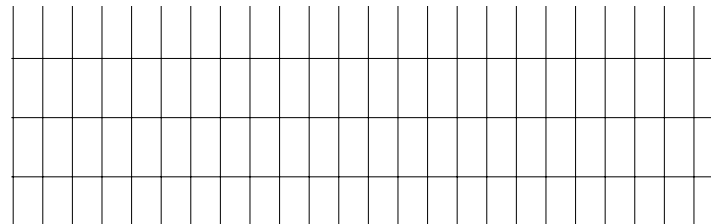

RIGATURA 2 COLONNE:



RIGATURA 10 F:

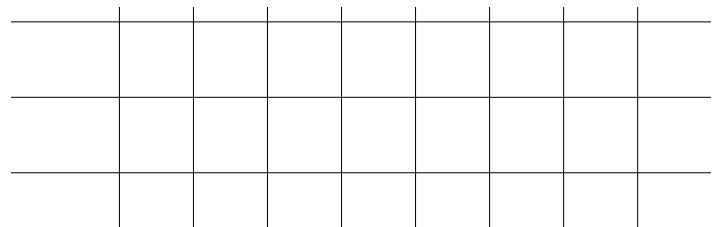

BIANCO / BCO

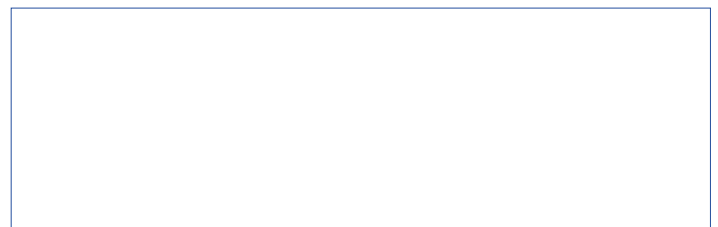

SOFT

Quaderno **formato A4** realizzato con **copertina in PPL da 35 micron** in **6 colori fluo**.
Carta interna 80 g/m², 26 + 1 fogli.

Cod. 02237/A

Rigatura: A

Cod. 02237/B

Rigatura: B

Cod. 02237/C

Rigatura: C

Cod. 02237/Q

Rigatura: Q

Cod. 02237/1R

Rigatura: 1R

Cod. 02237/5MM

Rigatura: 5 MM

Cod. 02237/4MM

Rigatura: 4 MM

Cod. 02237/10MM

Rigatura: 10 MM

 10
U.M.V.

 60
Imballo



SOFT PASTEL

Quaderno formato **A4** realizzato con **copertina in PPL da 35 micron** in **6 colori pastello**.
Carta interna 80 g/m², 26 + 1 fogli.

Cod. 57694/A

Rigatura: A

Cod. 57694/B

Rigatura: B

Cod. 57694/C

Rigatura: C

Cod. 57694/Q

Rigatura: Q

Cod. 57694/1R

Rigatura: 1R

Cod. 57694/5MM

Rigatura: 5 MM

Cod. 57694/4MM

Rigatura: 4 MM

Cod. 57694/10MM

Rigatura: 10 MM

 10
U.M.V.

 60
Imballo



TINTED **XXL** "NEON"

Quaderno **formato A4, 32+1 fogli da 80 g/m².**
 Copertina plastificata uv, 300 g/m².
 Disponibile in **6 colori fluo.**

Cod. 18966/A
 Rigatura: A

Cod. 18966/B
 Rigatura: B

Cod. 18966/C
 Rigatura: C

Cod. 18966/Q
 Rigatura: Q

Cod. 18966/1R
 Rigatura: 1R

Cod. 18966/5MM
 Rigatura: 5 MM

Cod. 18966/4MM
 Rigatura: 4 MM

Cod. 18966/10MM
 Rigatura: 10 MM

Cod. 18966/BCO
 Rigatura: Bianco

 10
 U.M.V.

 60
 Imballo

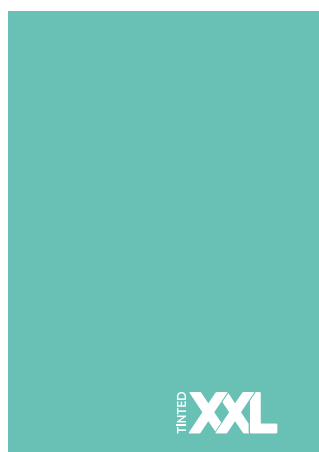

TINTED **XXL** "PASTEL"

Quaderno **formato A4, 32+1 fogli da 80 g/m².**
 Copertina plastificata uv, 300 g/m².
 Disponibile in **6 colori pastello.**

Cod. 20005/A
 Rigatura: A

Cod. 20005/B
 Rigatura: B

Cod. 20005/C
 Rigatura: C

Cod. 20005/Q
 Rigatura: Q

Cod. 20005/1R
 Rigatura: 1R

Cod. 20005/5MM
 Rigatura: 5 MM

Cod. 20005/4MM
 Rigatura: 4 MM

Cod. 20005/10MM
 Rigatura: 10 MM

Cod. 20005/BCO
 Rigatura: Bianco

 10
 U.M.V.

 60
 Imballo



TINTED
XL100

Quaderno **formato A4. 24 + 1 fogli da 100 gr.**
Disponibile in 6 colori.

Cod. 23777/A

Rigatura: A

Cod. 23777/B

Rigatura: B

Cod. 23777/C

Rigatura: C

Cod. 23777/Q

Rigatura: Q

Cod. 23777/1R

Rigatura: 1R

Cod. 23777/5MM

Rigatura: 5 MM

Cod. 23777/4MM

Rigatura: 4 MM

Cod. 23777/10MM

Rigatura: 10 MM

Cod. 23777/BCO

Rigatura: BCO

 10
U.M.V.

 60
Imballo

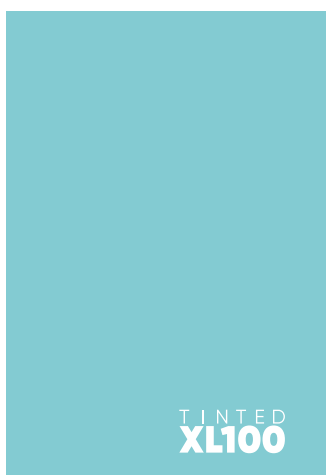

CARTONATO "TINTED"

Quaderno **formato A4**. Carta interna **80 g/m²**, **96 fogli**.
Disponibile in colori assortiti.

Cod. 11741/A

Rigatura: A

Cod. 11741/B

Rigatura: B

Cod. 11741/C

Rigatura: C

Cod. 11741/Q

Rigatura: Q

Cod. 11741/1R

Rigatura: 1R

Cod. 11741/5MM

Rigatura: 5 MM

Cod. 11741/4MM

Rigatura: 4 MM

Cod. 11741/10MM

Rigatura: 10 MM

 6
U.M.V.

 24
Imballo



"TINTED" 5

Quaderno **formato A5** con copertina **300 g/m²** bipatinata con vernice UV,
plastificazione opaca in **8 colori assortiti**. Carta interna **da 80 g/m²**, **20 + 1 fogli**.

Cod. 02238/A

Rigatura: A

Cod. 02238/B

Rigatura: B

Cod. 02238/C

Rigatura: C

Cod. 02238/Q

Rigatura: Q

Cod. 02238/1R

Rigatura: 1R

Cod. 02238/5MM

Rigatura: 5 MM

Cod. 02238/4MM

Rigatura: 4 MM

Cod. 02238/10MM

Rigatura: 10 MM

 12
U.M.V.

 48
Imballo



RUBRICA TINTED

Quaderno rubrica **formato A5**.
Disponibile in **6 colori assortiti**.

Cod. 13280/20

Modello: 20 fogli

Cod. 13280/30

Modello: 30 fogli

 10
U.M.V.

 60
Imballo



RICAMBIO RINFORZATO COLORATO

Banda antistrappo, formato A4, 80 fogli da 100g/m².

Cod. 06072/1R

Rigatura: 1 RIGO

Cod. 06072/5MM

Rigatura: 5 MM

Cod. 06072/4MM

Rigatura: 4 MM



RICAMBIO RINFORZATO BIANCO

Banda antistrappo, formato A4, 80 fogli da 100g/m².



Cod. 54334/A

Rigatura: A

Cod. 54334/1R

Rigatura: 1R

Cod. 54334/B

Rigatura: B

Cod. 54334/5MM

Rigatura: 5 MM

Cod. 54334/C

Rigatura: C

Cod. 54334/4MM

Rigatura: 4 MM

Cod. 54334/Q

Rigatura: Q

Cod. 54334/10MM

Rigatura: 10 MM





QUADERNO DI MUSICA

Formato A4, **16 fogli** pentagrammati, copertina 250 g/m² e carta interna da **100 g/m²**.

Cod. 27658

 10
U.M.V.

 60
Imballo





QUADERNO DI LATINO

Quaderno per facilitare l'apprendimento del latino, formato 17 x 24, **96 pagine 70 g/m²**.

Cod. 02936

20
U.M.V.

120
Imballo

FOGLIO DI LABORATORIO

Foglio di laboratorio **80 gr formato A4** a tre aperture.
Confezione da 50 pezzi.

Cod. 03407

1
U.M.V.

6
Imballo

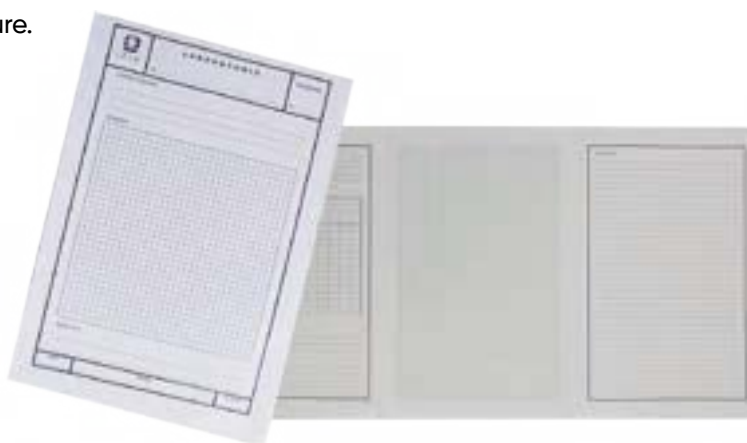

QUADERNO DI LABORATORIO

Quaderno formato A4 con **16 fogli 80 g/m²** e copertina 200 g/m².

Cod. 26097

25
U.M.V.

100
Imballo

CARTA PROTOCOLLO

Confezione da **200 fogli** piegati in **A4**.
Carta **60 g/m²**.



Cod. 22326/1R

Rigatura: 1R

Cod. 22326/4MM

Rigatura: 4MM

Cod. 22326/5MM

Rigatura: 5MM

Cod. 22326/CO

Rigatura: COMMERCIALE

Cod. 22326/UB

Rigatura: USO BOLLO

 1
U.M.V.

 10
Imballo

CARTA PROTOCOLLO

Confezione da **20 fogli** piegati in **A4**.
Carta **60 g/m²**.

Cod. 14592/1R

Rigatura: 1R

Cod. 14592/4MM

Rigatura: 4MM

Cod. 14592/5MM

Rigatura: 5MM

Cod. 14592/CO

Rigatura: COMMERCIALE

Cod. 14592/UB

Rigatura: USO BOLLO

 10
U.M.V.

 20
Imballo





Spil Notes 4

Formato **A4** (21 x 29,7 cm), carta bianca, copertina gofrata, sottoblocco e rilegatura a punti metallici. Blocco da **60 fogli**.

Cod. 19750/1R
Rigatura: 1R

Cod. 19750/5MM
Rigatura: 5 mm

Cod. 19750/BCO
Rigatura: Bianco

 10
U.M.V.

 60
Imballo



SpilNotes 5

Formato **A5** (14,8 x 21 cm), carta bianca, copertina gofrata, sottoblocco e rilegatura a punti metallici. Blocco da **60 fogli**.

Cod. 19751/1R

Rigatura: 1R

Cod. 19751/BCO

Rigatura: Bianco

Cod. 19751/5MM

Rigatura: 5 mm

 10
U.M.V.

 120
Imballo



SpilNotes 6

Formato **A6** (10 x 15 cm), carta bianca, copertina gofrata, sottoblocco e rilegatura a punti metallici, rigatura 5 mm. Blocco da **60 fogli**.

Cod. 19752

 10
U.M.V.

 240
Imballo

SpilNotes 7

Formato **A7** (8 x 12 cm), carta bianca, copertina gofrata, sottoblocco e rilegatura a punti metallici, rigatura 5 mm. Blocco da **60 fogli**.

Cod. 19753

 20
U.M.V.

 320
Imballo



SpilNotes[®] 4 SPIRALATO

Formato **A4** (21 x 29,7 cm), carta **60 g/m²**, sottoblocco e rilegatura con spirale in metallo bianca. Blocco da **60 fogli**. Confezione da 10 pezzi.

Cod. 24323/5MM

Rigatura: 5 mm



U.M.V.



Imballo



SpilNotes[®] 5 SPIRALATO

Formato **A5** (15 x 21 cm), carta **60 g/m²**, sottoblocco e rilegatura con spirale in metallo bianca. Blocco da **60 fogli**. Confezione da 10 pezzi.

Cod. 24324/5MM

Rigatura: 5 mm



U.M.V.



Imballo



PORTABLOCCO

Formato **23 x 32 cm**, in cartone rivestito,
1 ante, mollettone fermacarte.

Cod. 19708/NR

Cod. 19708/BL

Cod. 19708/RS

6
U.M.V.

60
Imballo



PORTABLOCCO

Formato **23 x 32 cm**, in cartone rivestito, **2 ante**,
tasca interna, mollettone fermacarte.

Cod. 19709/NR

Cod. 19709/BL

Cod. 19709/RS

6
U.M.V.

60
Imballo



PORTABLOCCO

Formato **23 x 32 cm**, **2 ante**, tasca interna, con clip,
dorso 1 cm, mollettone fermacarte.

Cod. 55929/NR

Cod. 55929/BL

12
U.M.V.

48
Imballo



PORTABLOCCO

In plastica rigida, **1 anta**, tavoletta 3 mm, **colori fluorescenti**, mollettone fermacarte.

Cod. 19685



12
U.M.V.

72
Imballo

Centimetri

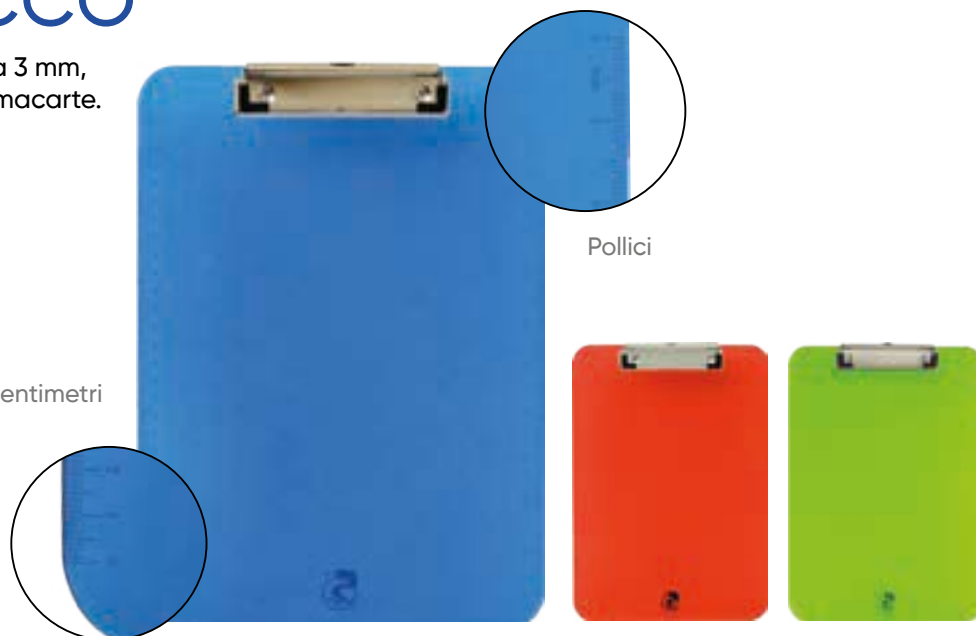

PORTABLOCCO

Formato **23 x 32 cm**, **1 anta**, tavoletta in MDF 3 mm.

Cod. 55928

12
U.M.V.

72
Imballo



Spil[®]Blok



**QUALUNQUE SIA LA TUA ESIGENZA, C'È UNO
SPILBLOK ADATTO A TE:
FLUO, PASTEL, DOTTED, BIG, CLASSIC.**

Tutti noi abbiamo le nostre preferenze quando si tratta di quaderni.

Alcuni cercano qualcosa di bello e comodo su cui scrivere, mentre altri cercano un quaderno particolare, grande, con molto spazio per i loro appunti.

Gli spilblok sono i quaderni ideali per tutti!





spirale

La spirale in metallo plastificato consente una corretta sovrapposizione delle pagine ed evita che queste si sporchino al contatto con le mani.



cartoncino

Il cartoncino posteriore da 900 gr. consente una maggiore stabilità di scrittura quando non si ha la possibilità di poggiarsi su una base solida.



fogli

I fogli dei nostri Spilblok sono da 80 gr/m², microperforati con invito allo strappo, senza fori e con fori per poter essere archiviati in raccoglitori ad anello.



elastico

Gli Spilblok della serie "e" sono provvisti di un elastico a chiusura per una migliore tenuta del quaderno nella borsa o nello zaino.

SpilBlok® 4 pastel

COLORI ASSORTITI*



Giallo



Lilla



Verde
acqua



Rosso



Celeste



Arancione

*Colori non acquistabili singolarmente



Formato A4

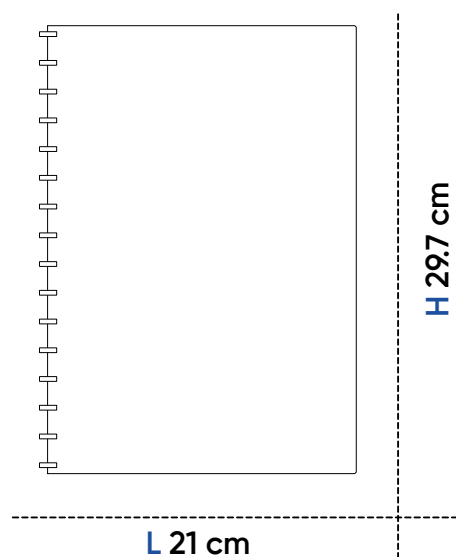

Grammatura 80 gr/m²

Fogli 80



Codice

55225/CF

55225/SF

55226/CF

55226/SF

55227/CF

55227/SF

55228

Rigatura

1R

1R

5 mm

5 mm

4 mm

4 mm

Bianco

Foratura

Con 4 fori

Senza fori

Con 4 fori

Senza fori

Con 4 fori

Senza fori

Senza fori

Imballo

30

30

30

30

30

30

30

U.M.V

6

6

6

6

6

6

6

SpilBlok® 4big pastel



COLORI ASSORTITI*



Giallo



Lilla



Verde
acqua



Rosso



Celeste



Arancione

*Colori non acquistabili singolarmente

Formato A4

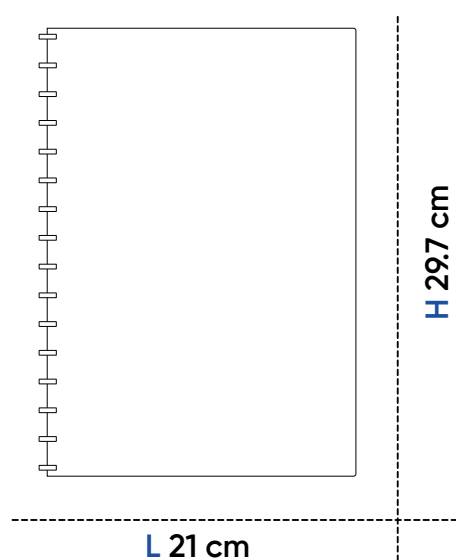

Grammatura 80 gr/m²

Fogli 144



Codice

55229/CF

55229/SF

55230/CF

55230/SF

Rigatura

1R

1R

5 mm

5 mm

Foratura

Con 4 fori

Senza fori

Con 4 fori

Senza fori

Imballo

20

20

20

20

U.M.V

2

2

2

2

SpilBlok® 4S pastel



COLORI ASSORTITI*



Giallo



Lilla



Verde
acqua



Rosso



Celeste



Arancione

*Colori non acquistabili singolarmente

Formato A4

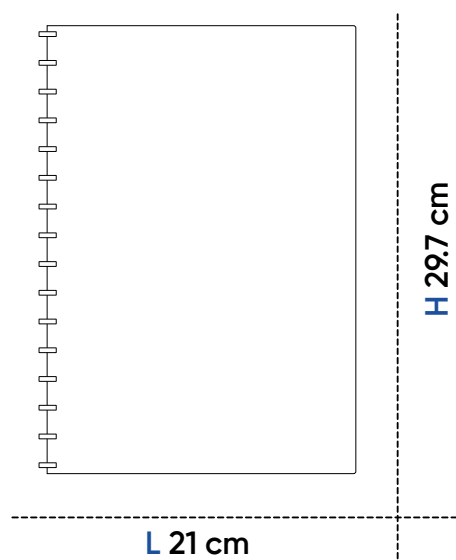

Grammatura 80 gr/m²

Fogli 150

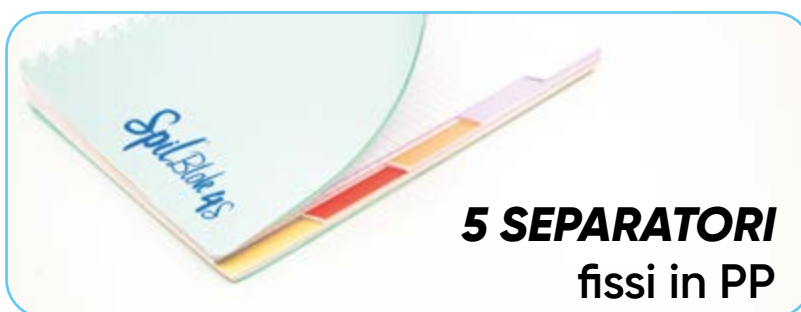

Codice

55231

Rigatura

1R

Foratura

Senza fori

Imballo

20

U.M.V

2

55232

5 mm

Senza fori

20

2

55233

1R - 5 mm - Bianco

Senza fori

20

2

SpilBlok[®] 4 dotted

COLORI ASSORTITI*



*Colori non acquistabili singolarmente

COPERTINA
in PP a nido d'ape

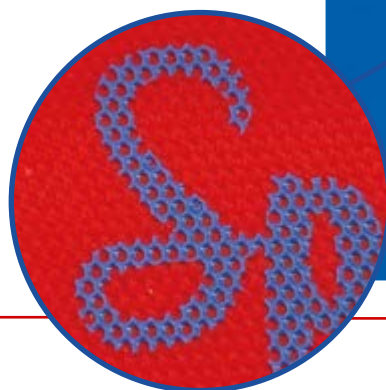

Formato
A4

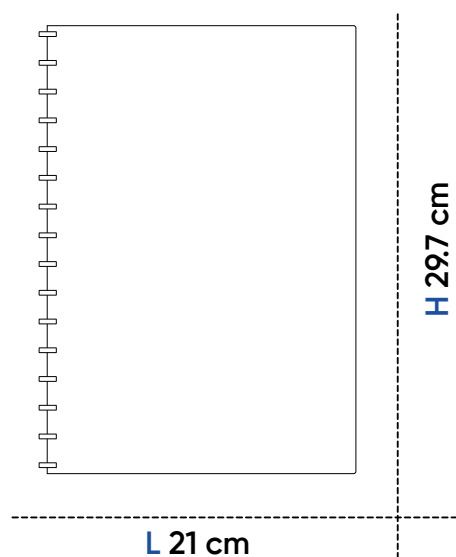

Grammatura
80 gr/m²

Fogli
80



Codice	Rigatura	Foratura	Imballo	U.M.V
55236/CF	1R	Con 4 fori	30	6
55236/SF	1R	Senza fori	30	6
55237/CF	5 mm	Con 4 fori	30	6
55237/SF	5 mm	Senza fori	30	6
55460/CF	4 mm	Con 4 fori	30	6
55460/SF	4 mm	Senza fori	30	6
55238	Bianco	Senza fori	30	6

SpilBlok® 4big dotted



COLORI ASSORTITI*



*Colori non acquistabili singolarmente

Formato A4

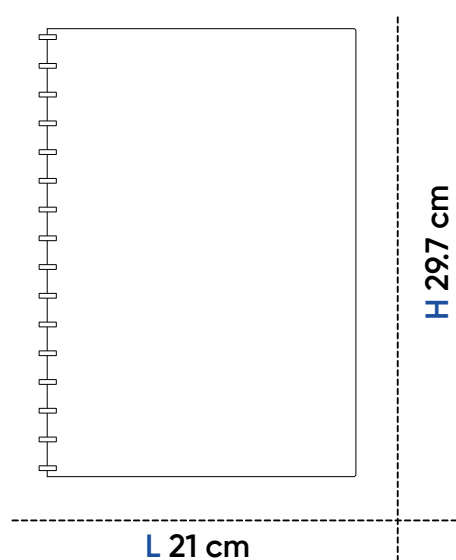

Grammatura 80 gr/m²

Fogli 144



Codice

55239/CF

55239/SF

55240/CF

55240/SF

56124

56124

Rigatura

1R

1R

5 mm

5 mm

Bianco

Bianco

Foratura

Con 4 fori

Senza fori

Con 4 fori

Senza fori

Con 4 fori

Senza fori

Imballo

20

20

20

20

20

20

U.M.V

2

2

2

2

2

2

SpilBlok[®] 4S dotted



COLORI ASSORTITI*



*Colori non acquistabili singolarmente

Formato A4

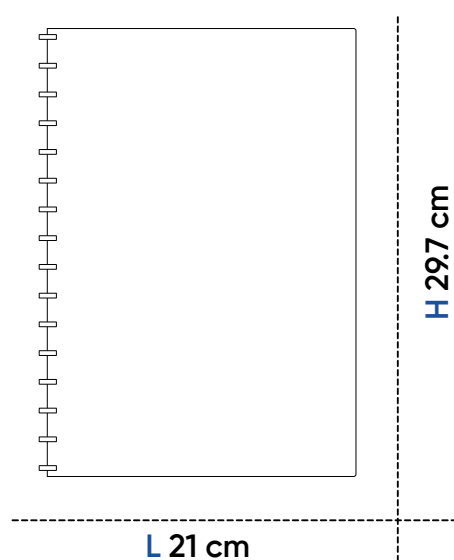

Grammatura 80 gr/m²

Fogli 150



5 SEPARATORI fissi in PP

Codice	Rigatura	Foratura	Imballo	U.M.V
55241	1R	Senza fori	20	2
55242	5 mm	Senza fori	20	2
55243	1R - 5 mm - Bianco	Senza fori	20	2

SpilBlok® 4 fluo



COLORI ASSORTITI*



Giallo



Viola



Verde



Fucsia



Blu



Arancione

*Colori non acquistabili singolarmente

Formato
A4

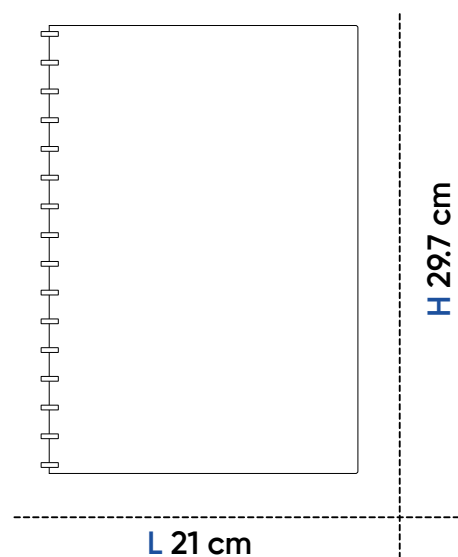

Grammatura
80 gr/m²

Fogli
80



Codice

Rigatura

Foratura

Imballo

U.M.V

19712/CF

1R

Con 4 fori

30

6

19712/SF

1R

Senza fori

30

6

19713/CF

5 mm

Con 4 fori

30

6

19713/SF

5 mm

Senza fori

30

6

10728/CF

4 mm

Con 4 fori

30

6

10728/SF

4 mm

Senza fori

30

6

27610

Bianco

Senza fori

30

6

28615/SF

10 mm

Senza fori

30

6

SpilBlok® 4big fluo



COLORI ASSORTITI*



Giallo



Viola



Verde



Fucsia



Blu



Arancione

*Colori non acquistabili singolarmente

Formato

A4

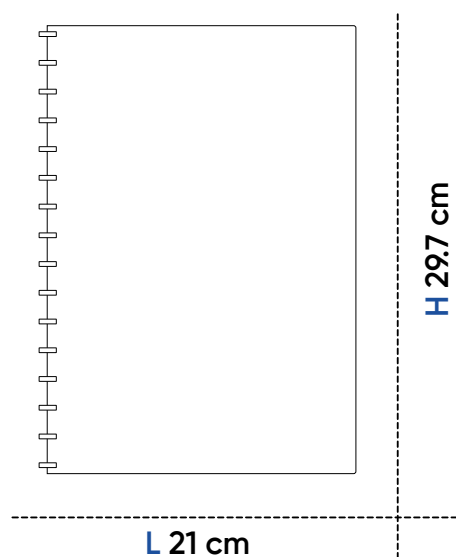

Grammatura

80 gr/m²

Fogli

144



Codice

19710/CF

19710/SF

19711/CF

19711/SF

27611

22608/SF

Rigatura

1R

1R

5 mm

5 mm

Bianco

4 mm

Foratura

Con 4 fori

Senza fori

Con 4 fori

Senza fori

Senza fori

Senza fori

Imballo

20

20

20

20

20

20

U.M.V

2

2

2

2

2

2

SpilBlok[®] 4S fluo



COLORI ASSORTITI*



Giallo



Viola



Verde



Fucsia



Blu



Arancione

*Colori non acquistabili singolarmente

Formato

A4

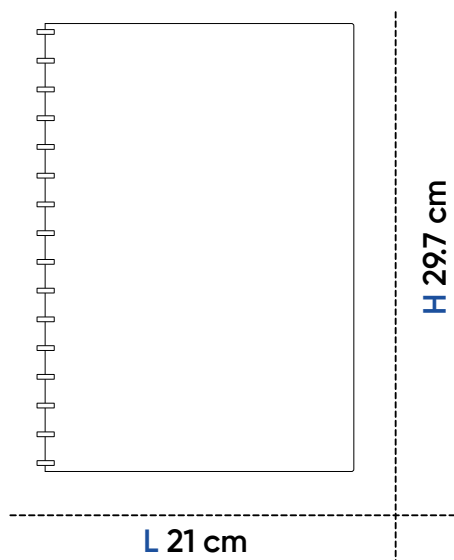

Grammatura

80 gr/m²

Fogli

150



5 SEPARATORI
fissi in PP

Codice

23036

Rigatura

1R

Foratura

Senza fori

Imballo

20

U.M.V

2

23037

5 mm

Senza fori

20

2

23081

1R - 5 mm - Bianco

Senza fori

20

2

22594

4 mm

Senza fori

20

2

SpilBlok 4D[®]

COLORI ASSORTITI*



*Colori non acquistabili singolarmente

TASCA
portafogli



Formato
A4

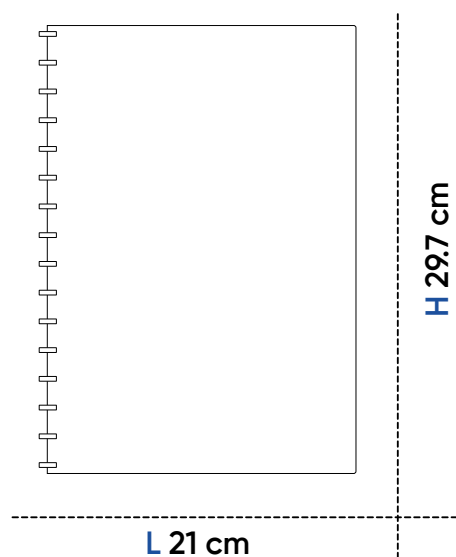

Grammatura
80 gr/m²

Fogli
80



1 SEPARATORE
rimovibile in PP

Codice	Rigatura	Foratura	Imballo	U.M.V
23034/CF	1R	Con 4 fori	36	6
23034/SF	1R	Senza fori	36	6
23035/CF	5 mm	Con 4 fori	36	6
23035/SF	5 mm	Senza fori	36	6



COLORI ASSORTITI*



*Colori non acquistabili singolarmente

Formato

19 x 26

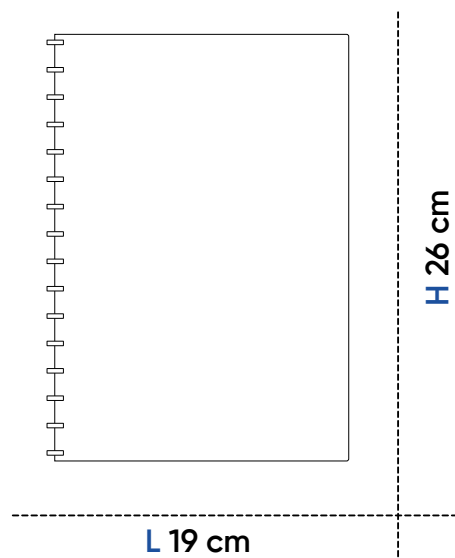

Grammatura

80 gr/m²

Fogli

80



Codice

26518

26519

29311

Rigatura

1R

5 mm

4 mm

Foratura

Senza fori

Senza fori

Senza fori

Imballo

36

36

36

U.M.V

6

6

6

SpilBlok[®] 4+ pastel



COLORI ASSORTITI*



Giallo



Lilla



Verde
acqua



Rosso



Celeste



Arancione

*Colori non acquistabili singolarmente

Formato

22.5 x 29.7

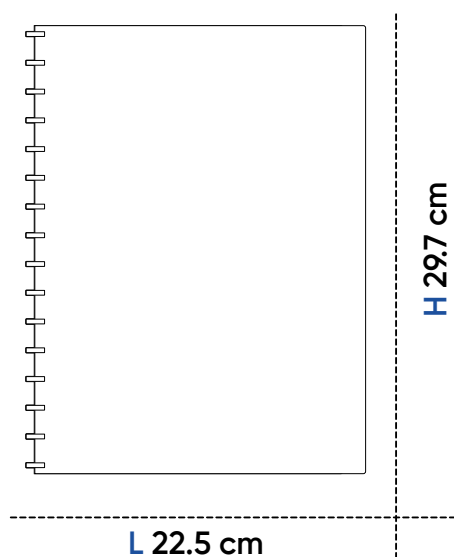

Grammatura

80 gr/m²

Fogli

80



Codice

18553/CF

18553/SF

18554/CF

18554/SF

Rigatura

1R

1R

5 mm

5 mm

Foratura

Con 4 fori

Senza fori

Con 4 fori

Senza fori

Imballo

36

36

36

36

U.M.V

6

6

6

6

SpilBlok® 4big+ pastel



COLORI ASSORTITI*



Giallo



Lilla



Verde
acqua



Rosso



Celeste



Arancione

*Colori non acquistabili singolarmente

Formato

22.5 x 29.7

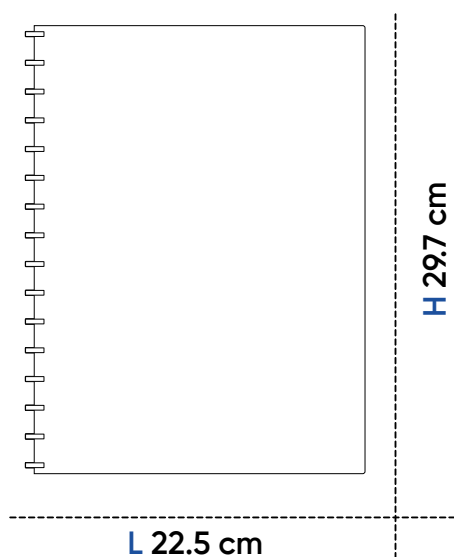

Grammatura

80 gr/m²

Fogli

144



Codice

18556/CF

18556/SF

18558/CF

18558/SF

Rigatura

1R

1R

5 mm

5 mm

Foratura

Con 4 fori

Senza fori

Con 4 fori

Senza fori

Imballo

20

20

20

20

U.M.V

2

2

2

2

SpilBlok 4S+ pastel



COLORI ASSORTITI*



Giallo



Lilla



Verde
acqua



Rosso



Celeste



Arancione

*Colori non acquistabili singolarmente

Formato

22.5 x 29.7

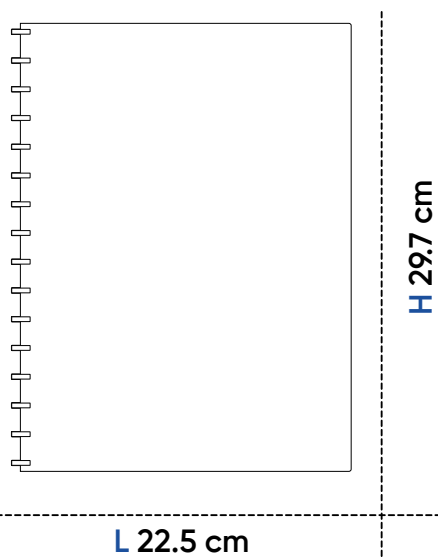

Grammatura

80 gr/m²

Fogli

150



Codice

18559/1R

18559/5MM

18559/ASS

Rigatura

1R

5 mm

1R - 5 mm - Bianco

Foratura

Senza fori

Senza fori

Senza fori

Imballo

20

20

20

U.M.V

2

2

2

SpilBlok[®] 4+ dotted

COLORI ASSORTITI*



*Colori non acquistabili singolarmente

COPERTINA
in PP a nido d'ape

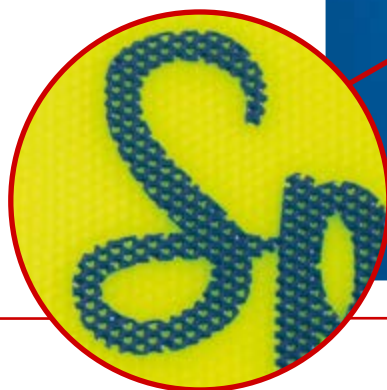

Formato
22.5 x 29.7

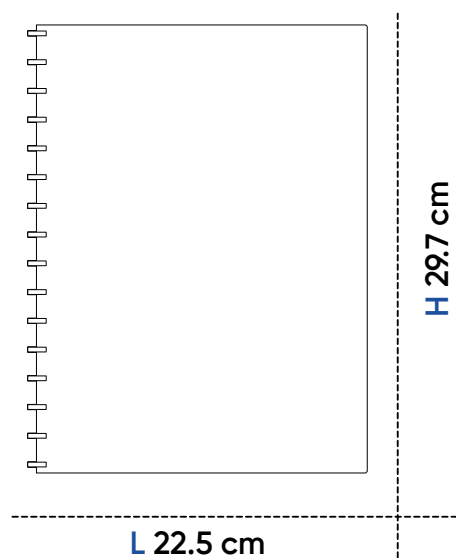

Grammatura
80 gr/m²

Fogli
80



Codice	Rigatura	Foratura	Imballo	U.M.V
19657/CF	1R	Con 4 fori	36	6
19657/SF	1R	Senza fori	36	6
19658/CF	5 mm	Con 4 fori	36	6
19658/SF	5 mm	Senza fori	36	6

SpilBlok® 4big+ dotted

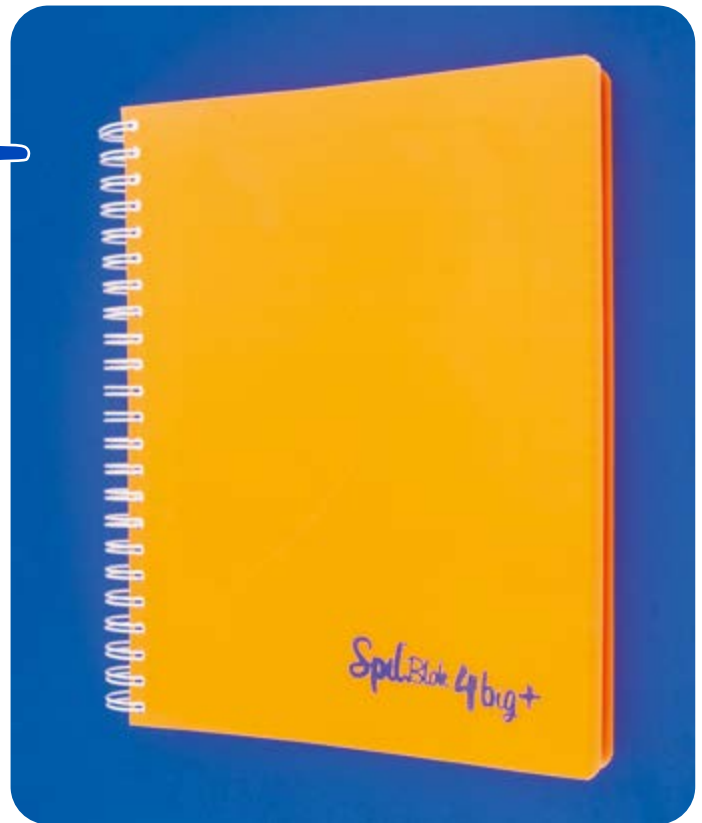

COLORI ASSORTITI*



*Colori non acquistabili singolarmente

Formato
22.5 x 29.7

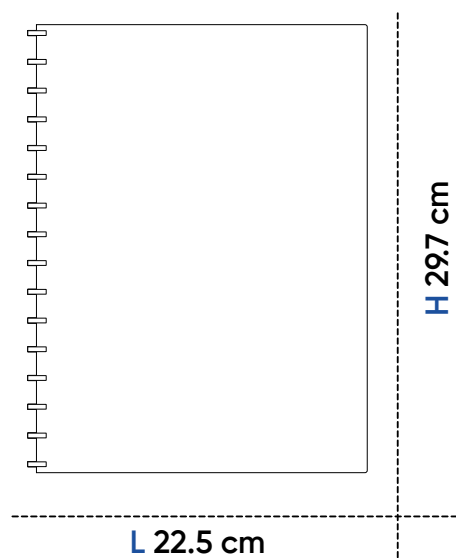

Grammatura
80 gr/m²

Fogli
144



Codice	Rigatura	Foratura	Imballo	U.M.V
19659/CF	1R	Con 4 fori	20	2
19659/SF	1R	Senza fori	20	2
19660/CF	5 mm	Con 4 fori	20	2
19660/SF	5 mm	Senza fori	20	2

SpilBlok® 4S+ dotted



COLORI ASSORTITI*



*Colori non acquistabili singolarmente

Formato
22.5 x 29.7

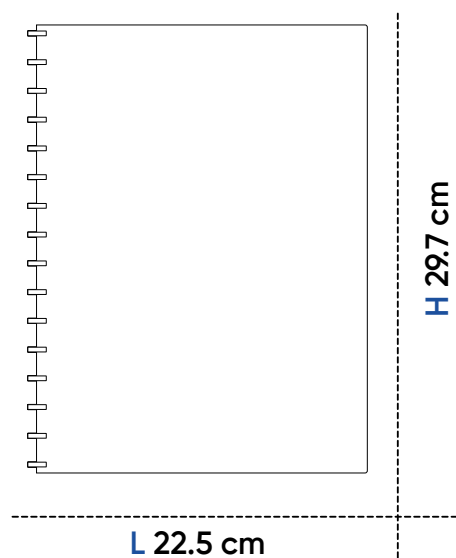

Grammatura
80 gr/m²

Fogli
150



Codice	Rigatura	Foratura	Imballo	U.M.V
19665/1R	1R	Senza fori	20	2
19665/5MM	5 mm	Senza fori	20	2
19665/ASS	1R - 5 mm - Bianco	Senza fori	20	2

SpilBlok[®] 4+ fluo



COLORI ASSORTITI*



Giallo



Viola



Verde



Fucsia



Blu



Arancione

*Colori non acquistabili singolarmente

Formato
22.5 x 29.7

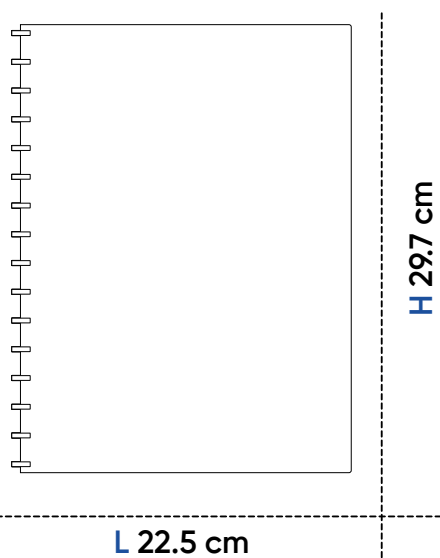

Grammatura
80 gr/m²

Fogli
80



Codice

19929/CF

19929/SF

19930/CF

19930/SF

Rigatura

1R

1R

5 mm

5 mm

Foratura

Con 4 fori

Senza fori

Con 4 fori

Senza fori

Imballo

36

36

36

36

U.M.V

6

6

6

6

SpilBlok® 4big+ fluo



COLORI ASSORTITI*



Giallo



Viola



Verde



Fucsia



Blu



Arancione

*Colori non acquistabili singolarmente

Formato

22.5 x 29.7

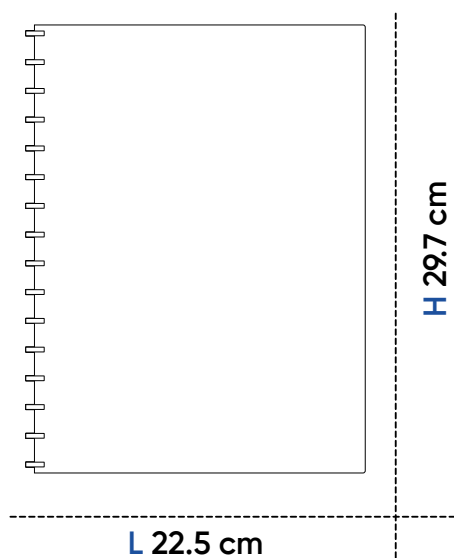

Grammatura

80 gr/m²

Fogli

144



Codice

19931/CF

Rigatura

1R

Foratura

Con 4 fori

Imballo

20

U.M.V

2

19931/SF

1R

Senza fori

20

2

19932/CF

5 mm

Con 4 fori

20

2

19932/SF

5 mm

Senza fori

20

2

SpilBlok 4S+ fluo



COLORI ASSORTITI*



Giallo



Viola



Verde



Fucsia



Blu



Arancione

*Colori non acquistabili singolarmente

Formato

22.5 x 29.7

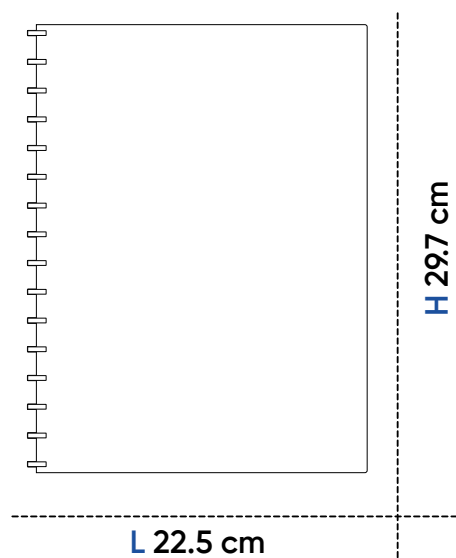

Grammatura

80 gr/m²



Fogli

150



5 SEPARATORI
fissi in PP

Codice

19940/1R

19940/5MM

19940/ASS

Rigatura

1R

5 mm

1R - 5 mm - Bianco

Foratura

Senza fori

Senza fori

Senza fori

Imballo

20

20

20

U.M.V

2

2

2

SpilBlok 5[®]

COLORI ASSORTITI*



*Colori non acquistabili singolarmente

Formato A5

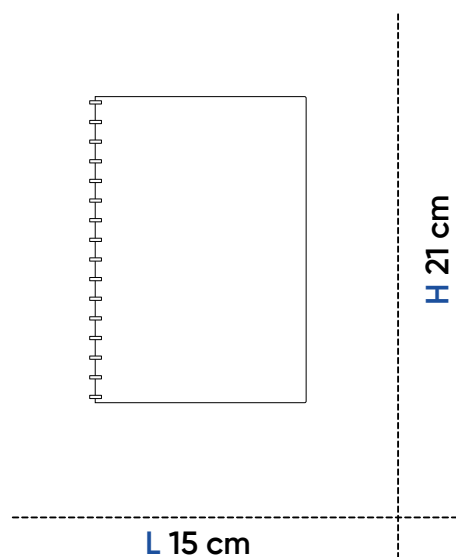

Grammatura 80 gr/m²

Fogli 80



Codice

19714/CF

19714/SF

19715/CF

19715/SF

22597/CF

22597/SF

Rigatura

1R

1R

5 mm

5 mm

4 mm

4 mm

Foratura

Con 4 fori

Senza fori

Con 4 fori

Senza fori

Con 4 fori

Senza fori

Imballo

36

36

36

36

36

36

U.M.V

6

6

6

6

6

6

SpilBlok® 6

COLORI ASSORTITI*



*Colori non acquistabili singolarmente



Formato
A6

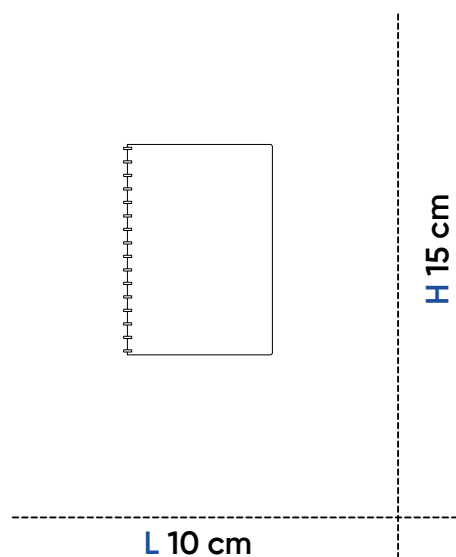

Grammatura
80 gr/m²

Fogli
80



Codice
19716
19717

Rigatura
1R
5 mm

Foratura
Senza fori
Senza fori

Imballo
36
36

U.M.V
6
6

SpilBlok[®] 7

COLORI ASSORTITI*

					
Giallo	Lilla	Verde acqua	Rosso	Celeste	Arancione
					
Rosso	Nero	Blu	Giallo	Verde	Arancione
					
Giallo	Viola	Verde	Fucsia	Blu	Arancione



*Colori non acquistabili singolarmente

Formato
A7

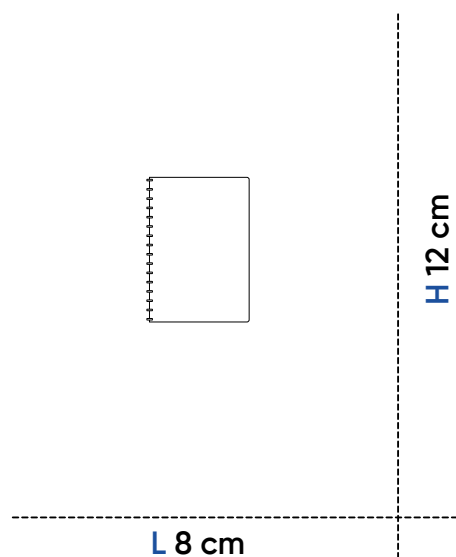

Grammatura
80 gr/m²

Fogli
80



Codice
19719

Rigatura
5 mm

Foratura
Senza fori

Imballo
36

U.M.V
6

SpilBlok[®] 4e

COLORI ASSORTITI*



*Colori non acquistabili singolarmente

Formato A4

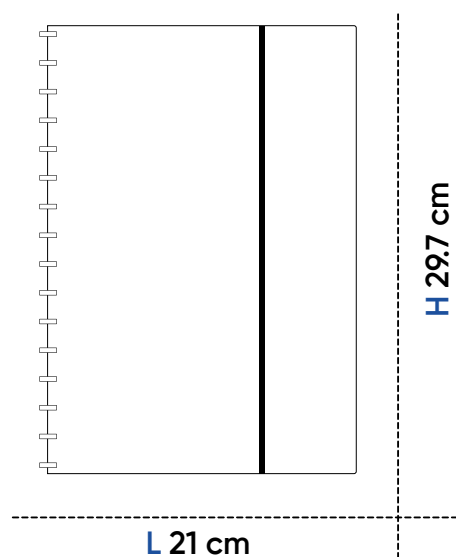

Grammatura 80 gr/m²

Fogli 60



Codice	Rigatura	Foratura	Imballo	U.M.V
26463/CF	1R	Con 4 fori	36	6
26463/SF	1R	Senza fori	36	6
26464/CF	5 mm	Con 4 fori	36	6
26464/SF	5 mm	Senza fori	36	6
10729/CF	4 mm	Con 4 fori	36	6
10729/SF	4 mm	Senza fori	36	6

SpilBlok 5e

COLORI ASSORTITI*



*Colori non acquistabili singolarmente

Formato
A5

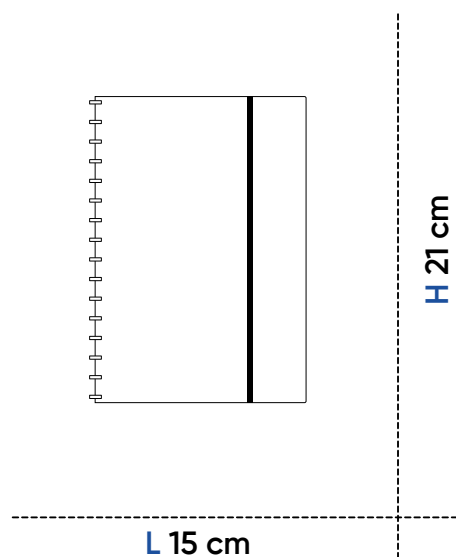

Grammatura
80 gr/m²

Fogli
60



Codice

Rigatura

Foratura

Imballo

U.M.V

26465/CF

1R

Con 4 fori

36

6

26465/SF

1R

Senza fori

36

6

26466/CF

5 mm

Con 4 fori

36

6

26466/SF

5 mm

Senza fori

36

6

SpilBlok® ge

COLORI ASSORTITI*



Formato

9 x 12

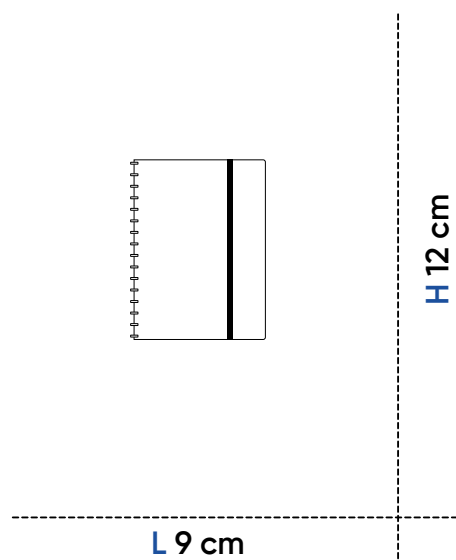

Grammatura

80 gr/m²

Fogli

60



Codice

26470

26471

Rigatura

1R

5 mm

Foratura

Senza fori

Senza fori

Imballo

36

36

U.M.V

6

6

SpilBlok® 6e

COLORI ASSORTITI*



*Colori non acquistabili singolarmente

Formato
A6

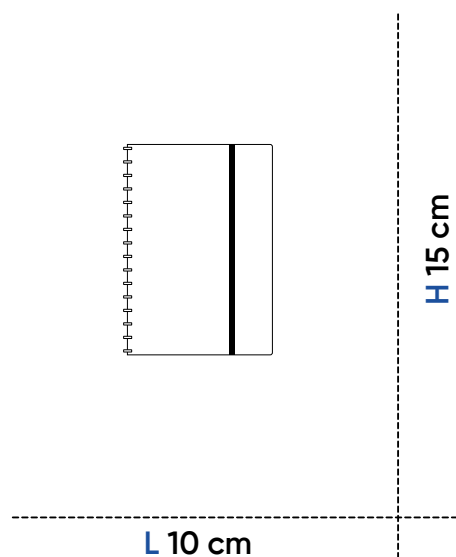

Grammatura
80 gr/m²

Fogli
60



Codice
26467
26468

Rigatura
1R
5 mm

Foratura
Senza fori
Senza fori

Imballo
36
36

U.M.V
6
6

SpilBlok[®] 7e

COLORI ASSORTITI*

					
Giallo	Lilla	Verde acqua	Rosso	Celeste	Arancione
					
Rosso	Nero	Blu	Giallo	Verde	Arancione
					
Giallo	Viola	Verde	Fucsia	Blu	Arancione



*Colori non acquistabili singolarmente

Formato

A7

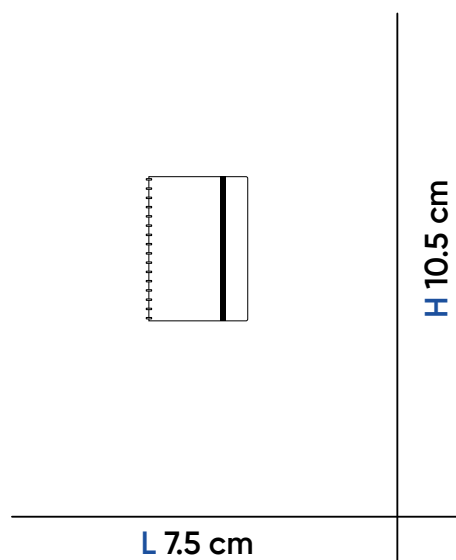

Grammatura

80 gr/m²

Fogli

60



Codice
26469

Rigatura
5 mm

Foratura
Senza fori

Imballo
36

U.M.V
6

SpilBlok®

COLORI ASSORTITI*



*Colori non acquistabili singolarmente



Formato A4

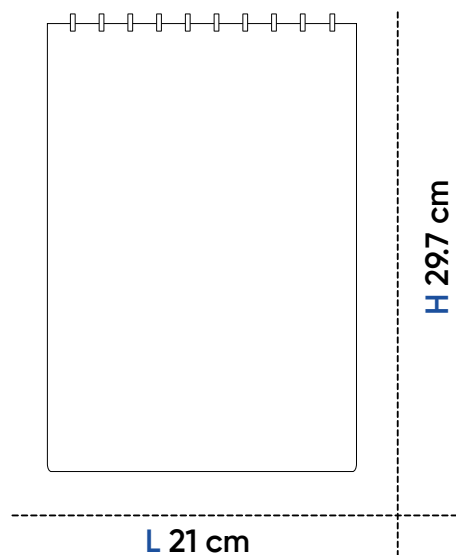

Grammatura 80 gr/m²

Fogli 144



Codice	Rigatura	Foratura	Imballo	U.M.V
19720/CF	1R	Con 4 fori	18	6
19720/SF	1R	Senza fori	18	6
19721/CF	5 mm	Con 4 fori	18	6
19721/SF	5 mm	Senza fori	18	6
23033/CF	Bianco	Con 4 fori	18	6
23033/SF	Bianco	Senza fori	18	6

SpilBlok 2[®]

COLORI ASSORTITI*



*Colori non acquistabili singolarmente

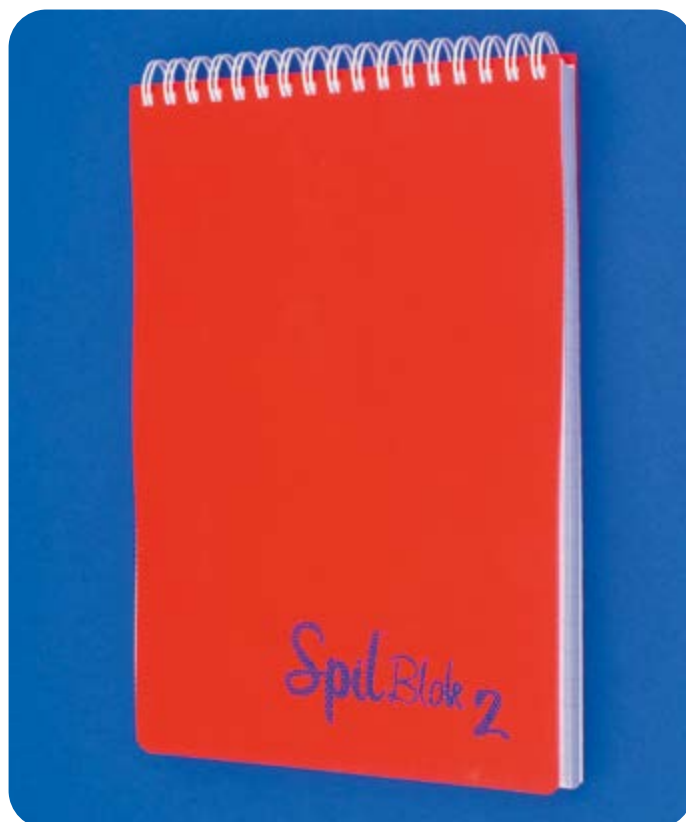

Formato
A5

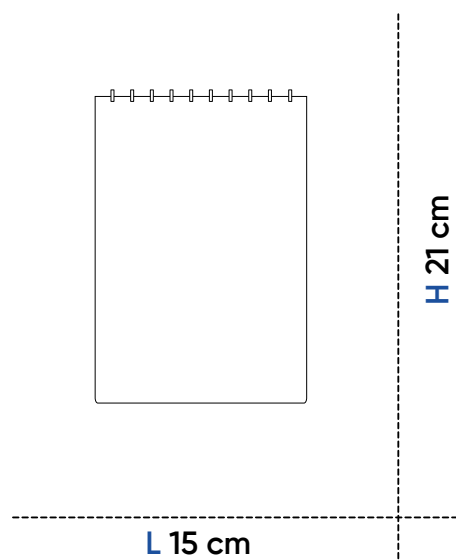

Grammatura
80 gr/m²

Fogli
144



Codice

19722/SF

19723/CF

19723/SF

Rigatura

1R

5 mm

5 mm

Foratura

Senza fori

Con fori

Senza fori

Imballo

36

36

36

U.M.V

6

6

6

SPIBLOK_{4BIG} CLASSIC

COLORI ASSORTITI*



*Colori non acquistabili singolarmente



Formato A4

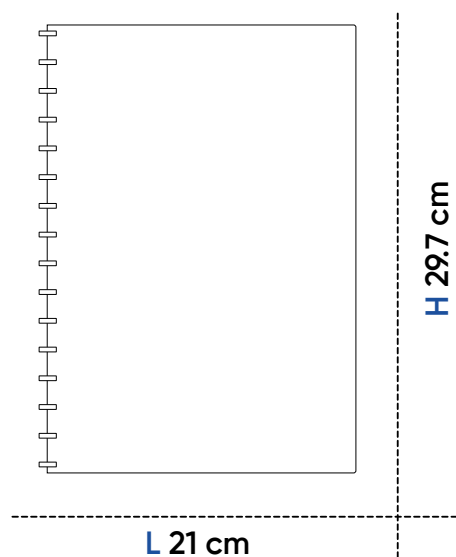

Grammatura 80 gr/m²

Fogli 144



Codice

23042

23043

27609

Rigatura

1R

5 mm

Bianco

Foratura

Senza fori

Senza fori

Senza fori

Imballo

20

20

20

U.M.V

2

2

2

SPIBLOK₁ CLASSIC

COLORI ASSORTITI*



*Colori non acquistabili singolarmente



Formato A4

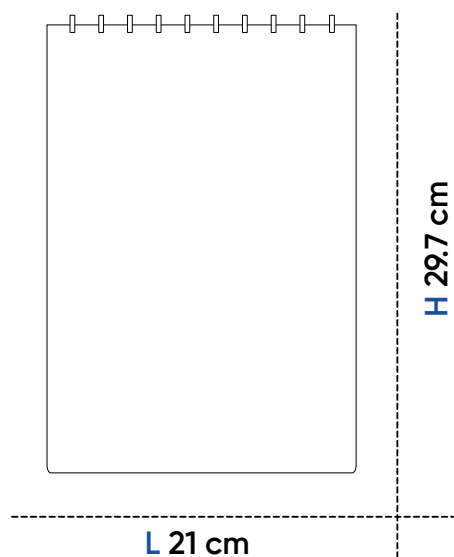

Grammatura 80 gr/m²

Fogli 144



Codice
23040
23041

Rigatura
1R
5 mm

Foratura
Senza fori
Senza fori

Imballo
36
36

U.M.V
6
6

Espositore da terra

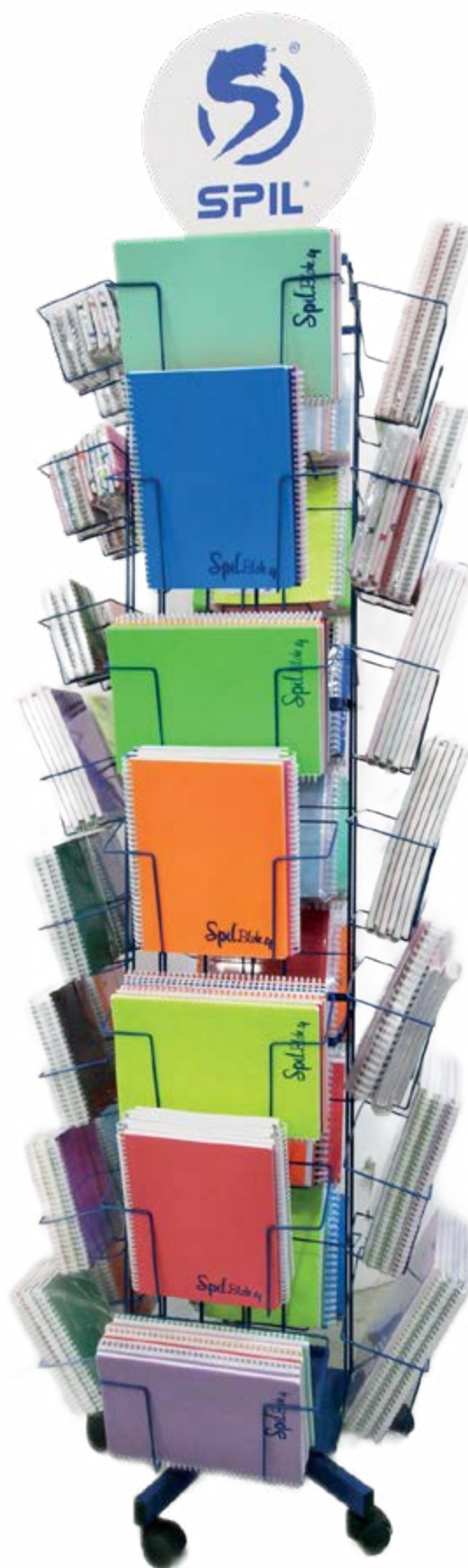

H 38 cm
RIMOVIBILE

H 195 cm

L 65 cm

Codice
07992/G

“ Crediamo che scrivere sia una parte fondamentale dell'apprendimento e un esercizio spontaneo che ha il potere di aprire la mente e accendere la creatività. ”



*Spil protegge e personalizza
i tuoi LIBRI con STILE*

5

COPRILIBRI e COPRIMAXI

COPRILIBRI	122
COPRIMAXI	123
ETICHETTE PER LIBRI	124

ROTOLO COPRILIBRO PP

Trasparente, liscio, colore neutro.

5

Cod. 18901/TR

Lunghezza: 1,5 Mt

Cod. 07273/TR

Lunghezza: 5 Mt

 50
U.M.V.

 50
Imballo

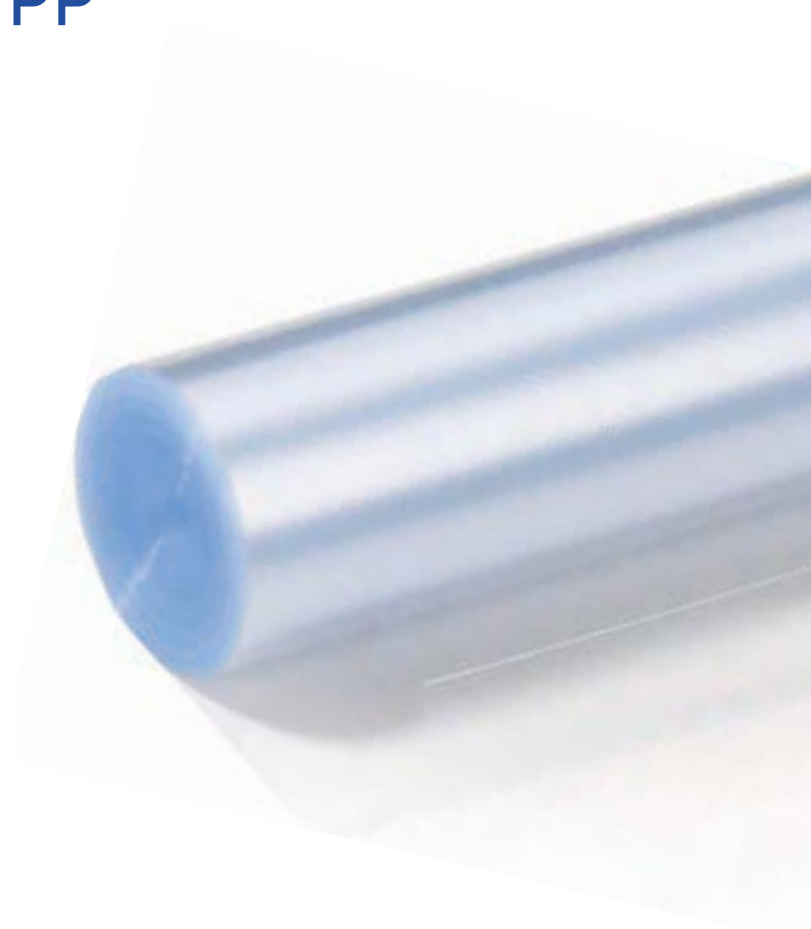

COPERTINA COPRILIBRI IN PP

Con **strip** adesiva,
confezione da 20 pezzi.

Cod. 04370/TR

Formato: Standard

Cod. 04722/TR

Formato: XL

Cod. 04370/ASS

Formato: Standard

 20
U.M.V.

 100
Imballo



 20
U.M.V.

 200
Imballo

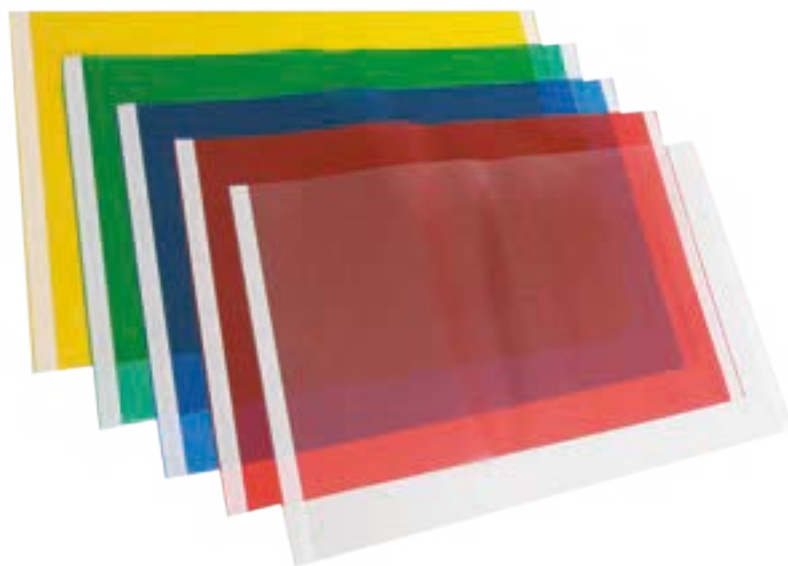

COPRIMAXI IN PP

Con **alette**, confezione da 20 pezzi.

Cod. 04376/TR

Cod. 04376/ASS



 20  100
U.M.V. Imballo

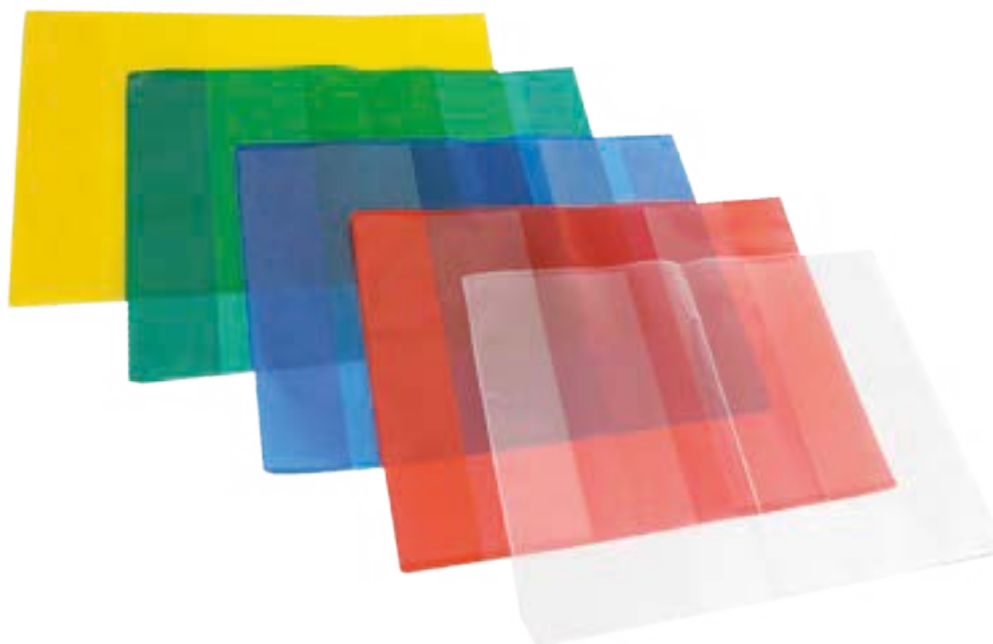

COPRIMAXI IN PVC

Finitura **goffrata**, taschetta portanome, **alette**, confezione da 25 pezzi.

Cod. 54703/TR

Cod. 54703/ASS



 25  100
U.M.V. Imballo



COPRIMAXI IN PVC LISCIO



Banda rinforzata, taschetta portanome e **alette**.
Confezione da 25 pezzi per colore.

- | | |
|---------------|----------------|
| Cod. 04377/AR | Cod. 04377/LI |
| Cod. 04377/BL | Cod. 04377/RO |
| Cod. 04377/CL | Cod. 04377/RS |
| Cod. 04377/FC | Cod. 04377/VRC |
| Cod. 04377/GL | Cod. 04377/VR |

 25 U.M.V.
  100 Imballo

COPRIMAXI LACCATI COPRENTI

In **PVC** liscio, con taschetta portanome e **alette**.
Confezione da 25 pezzi per colore.



- | | |
|---------------|----------------|
| Cod. 04378/NR | Cod. 04378/VRC |
| Cod. 04378/AR | Cod. 04378/GL |
| Cod. 04378/BN | Cod. 04378/MR |
| Cod. 04378/BL | Cod. 04378/RO |
| Cod. 04378/AZ | Cod. 04378/RS |
| Cod. 04378/FC | Cod. 04378/VR |
| Cod. 04378/TC | Cod. 04379/LL |

 25 U.M.V.
  100 Imballo



ETICHETTE PER LIBRI

Su foglio **A4**, espositore da 200 fogli.

Cod. 54330

 200 U.M.V.
  1000 Imballo

ETICHETTE

Autoadesive multiuso **pretagliate**, buste da 10 fogli.

Cod. 19784/01 Formato: 34 x 5	Cod. 19784/07 Formato: 73 x 37
Cod. 19784/02 Formato: 56 x 10	Cod. 19784/08 Formato: 70 x 56
Cod. 19784/03 Formato: 46 x 27	Cod. 19784/09 Formato: 83 x 53
Cod. 19784/04 Formato: 58 x 27	Cod. 19784/10 Formato: 110 x 34
Cod. 19784/05 Formato: 58 x 34	Cod. 19784/11 Formato: 110 x 46
Cod. 19784/06 Formato: 70 x 27	Cod. 19784/12 Formato: 115 x 70

 10
U.M.V.

 25
Imballo



ESPOSITORE ETICHETTE

Espositore da banco in cartone 300 pezzi, 25 pezzi per modello.

Cod. 19784/ESP
Formato: 34 x 5

 1
U.M.V.

 1
Imballo

Piccoli Geni crescono con Spil!

6

$$E = mc^2$$



Calcolatrici

TASCABILI.....	128
DA BANCO.....	132
SCIENTIFICHE.....	135



CALCOLATRICE TASCABILE

Custodia rigida, doppia alimentazione e tasti gommati.

Cod. 15210

Cifre: 8

Dimensioni: 105 x 65 x 9 mm

1
U.M.V.

200
Imballo

GARANZIA
2
ANNI

8
CIFRE



CALCOLATRICE TASCABILE

Custodia a libretto in PVC, doppia alimentazione e tasti gommati.

Cod. 15207

Cifre: 8

Dimensioni: 105 x 65 x 9 mm

1
U.M.V.

100
Imballo

GARANZIA
2
ANNI

8
CIFRE



CALCOLATRICE TASCABILE

Custodia rigida, doppia alimentazione e tasti gommati.

Cod. 14979

Cifre: 8

Dimensioni: 96 x 60 x 10 mm



1 U.M.V.

200 Imballo

GARANZIA
2 ANNI

8 CIFRE



6

CALCOLATRICE TASCABILE

Custodia rigida, doppia alimentazione e tasti gommati.

Cod. 15206

Cifre: 8

Dimensioni: 96x 63 x 12 mm



1 U.M.V.

200 Imballo

GARANZIA
2 ANNI

8 CIFRE



CALCOLATRICE TASCABILE

Calcolatrice tascabile con custodia rigida, doppia alimentazione e tasti gommati.

6

Cod. 15208

Cifre: 10

Dimensioni: 120 x 75 x 11,5 mm



1 U.M.V.

100 Imballo

GARANZIA
2 ANNI

10 CIFRE



CALCOLATRICE TASCABILE

Custodia rigida, doppia alimentazione e tasti gommati.



Cod. 15211

Cifre: 12

Dimensioni: 103x 69 x 10 mm



1 U.M.V.

200 Imballo

GARANZIA
2 ANNI

12 CIFRE



CALCOLATRICE TASCABILE

Chiusura a libretto in PVC, doppia alimentazione e tasti gommati.

Cod. 14980

Cifre: 12

Dimensioni: 96 x 63 x 10 mm



1 U.M.V.

200 Imballo

GARANZIA
2 ANNI

12 CIFRE



6

CALCOLATRICE TASCABILE

Custodia rigida, doppia alimentazione e tasti gommati.

Cod. 15212

Cifre: 12

Dimensioni: 117 x 73 x 10 mm



1 U.M.V.

200 Imballo

GARANZIA
2 ANNI

12 CIFRE



CALCOLATRICE TASCABILE

Calcolatrice tascabile, doppia alimentazione e tasti gommati.

6

Cod. 14978

Cifre: 12

Dimensioni: 115 x 58,5 x 9,6 mm



1 U.M.V.

100 Imballo

GARANZIA
2
ANNI

12
CIFRE



CALCOLATRICE DA BANCO

Con display inclinato per visione facilitata, doppia alimentazione e tasti rigidi.

Cod. 14977

Cifre: 12

Dimensioni: 148 x 105 x 27 mm



1 U.M.V.

50 Imballo

GARANZIA
2
ANNI

12
CIFRE



CALCOLATRICE DA BANCO

Con display inclinato per visione facilitata, doppia alimentazione e tasti rigidi.

Cod. 14976

Cifre: 12

Dimensioni: 146 x 100 x 29,6 mm



1 U.M.V.

50 Imballo

GARANZIA
2 ANNI

12 CIFRE



6

CALCOLATRICE DA BANCO

Con display inclinato per visione facilitata, doppia alimentazione e tasti in plastica.

Cod. 15205

Cifre: 12

Dimensioni: 174 x 109 x 26 mm



1 U.M.V.

80 Imballo

GARANZIA
2 ANNI

12 CIFRE



CALCOLATRICE DA BANCO

Con display inclinato per visione facilitata, doppia alimentazione e tasti XL.

6

Cod. 14975

Cifre: 12

Dimensioni: 186 x 134 x 40,5 mm



1 U.M.V.

50 Imballo

GARANZIA
2 ANNI

12 CIFRE

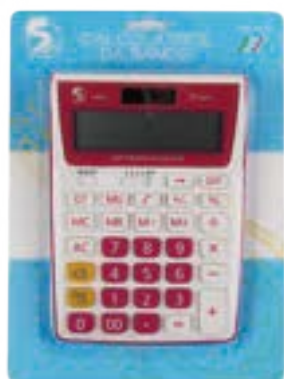

CALCOLATRICE DA BANCO

Con display inclinato per visione facilitata, doppia alimentazione e tastiera professionale.



Cod. 15204

Cifre: 12

Dimensioni: 176x 127 x 35 mm



1 U.M.V.

40 Imballo

GARANZIA
2 ANNI

12 CIFRE



CALCOLATRICE SCIENTIFICA

Display 10 + 2 cifre, a due linee, custodia rigida, 240 funzioni.

Ammessa all'esame di stato



Cod. 15213

Cifre: 10 + 2

Dimensioni: 186 x 134 x 40,5 mm

1 U.M.V.

50 Imballo



CALCOLATRICE SCIENTIFICA

10 + 2 cifre, a due linee, custodia rigida, 279 funzioni.

Ammessa all'esame di stato



Cod. 15214

Cifre: 10 + 2

Dimensioni: 170 x 80 x 16 mm

1 U.M.V.

50 Imballo



CALCOLATRICE SCIENTIFICA

Display dot matrix, custodia rigida, 249 funzioni.

Ammissa all'esame di stato



Cod. 55211

Cifre: Dot matrix

Dimensioni: 186 x 134 x 40,5 mm



CALCOLATRICE SCIENTIFICA

Display 10 + 2, custodia rigida, 417 funzioni.

Ammissa all'esame di stato



Cod. 55212

Cifre: 10 + 2

Dimensioni: 162 x 749 x 15 mm



CALCOLATRICE SCIENTIFICA

Display **dot matrix**, 417 funzioni, custodia rigida.

Ammessa all'esame di stato



Cod. 15215

Cifre: Dot matrix

Dimensioni: 164,5 x 84 x 15,5 mm



1 U.M.V.

50 Imballo



CALCOLATRICI SCIENTIFICHE IDONEE ALL'ESAME DI STATO



Apprendi con Spil!



Dipattica

FORBICINE	140
ABACO	142
REGOLI	142
BLOCCHI LOGICI.....	143



TAGLIACCIOI

FORBICI con BASE

Forbici con base, L. 13 cm, punta arrotondata, impugnatura modellata. Espositore da 12 pezzi (4 per soggetto).

Cod. 21504/01

Cod. 21504/02

Cod. 21504/03



1

U.M.V.



4

Imballo



1

U.M.V.



4

Imballo



1

U.M.V.



4

Imballo



ANIMALI

Forbici fantasia animali, L. 13,5 cm, punta arrotondata. Espositore da 32 pezzi (8 per soggetto).

Cod. 55256



1

U.M.V.



4

Imballo



TAGLIA & RITAGLIA

Forbici, L. 13 cm, punta arrotondata, impugnatura modellata. Espositore da 30 pezzi assortiti.

Cod. 14466



1

U.M.V.



4

Imballo





LEFTI

Forbici centimtrate per mancini, **L. 13,5 cm**, punta arrotondata. Espositore da **30 pezzi**.

Cod. 19149

1
U.M.V.

4
Imballo



7

CENTIMETRATE

Forbici centimtrate, **L. 13,5 cm**, punta arrotondata. Espositore da **30 pezzi** assortiti.

Cod. 15197

1
U.M.V.

4
Imballo



RETURN

Forbici centimtrate, **L. 13,5 cm**, punta arrotondata, meccanismo di riapertura automatico. Espositore da **30 pezzi** assortiti.

Cod. 15198

1
U.M.V.

4
Imballo



ABACO

Valigetta abaco contenente **16 aste** e **36 palline**.

Cod. 15715



1

U.M.V.



24

Imballo



NUMERI IN COLORE

Valigetta didattica regoli colorati contenente **200 pezzi** in **10 formati** per facilitare l'apprendimento dei concetti matematici per i piú piccoli.

Cod. 15725



1

U.M.V.



24

Imballo





FIGURE LOGICHE

Valigetta figure logiche geometriche
contentente **60 pezzi** in **4 forme**.

Cod. 15716

1
U.M.V.

24
Imballo



Colle VERSATILI PER INFINITE POSSIBILITÀ!



Colle e collanti

GEL STIK.....	146
COLLA VINYL.....	146
COLLA LIQUIDA.....	147
COLLA GLITTER.....	148
GLITTER.....	150
SUPER GLUE.....	151
TRA TAK.....	151
PICIKO.....	151
PISTOLA A CALDO.....	152
NASTRO TRASPARENTE.....	154
NASTRO IMBALLO.....	155
DISPENSER.....	156
NASTRO BIADESIVO.....	157
NASTRO INVISIBILE.....	158
NASTRO CARTA.....	158
NASTRO ISOLANTE.....	158
NASTRO TELATO.....	159
NASTRO SEGNALATORE.....	159
ETICHETTE IN BUSTA.....	160
ETICHETTE IN A4.....	162
PREZZATRICI.....	166

izistik

Colla Stick 15 g, colorata, prodotto atossico, **asciugatura rapida**, adatto per tessuto, carta e cartoncino, in fase di asciugatura la colla diventa **trasparente**. In display da 24 pezzi.

Cod. 21432/15

Formato: 15 g

12
U.M.V.

576
Imballo



Gelstik

Colla Stick multiuso per casa, lavoro e scuola. Prodotto atossico, **asciugatura rapida**, adatto per tessuto, carta e cartoncino.

Cod. 19472/10

Formato: 10 g

24
U.M.V.

96
Imballo

Cod. 19472/40

Formato: 40 g

12
U.M.V.

48
Imballo

Cod. 19472/20

Formato: 20 g

12
U.M.V.

48
Imballo



Colla **vinilica** bianca multiuso, **atossica e lavabile**. Per carta, tessuto, legno e ceramica.

Cod. 09205/100

Formato: 100 g

12
U.M.V.

72
Imballo

Cod. 09205/250

Formato: 250 g

12
U.M.V.

36
Imballo

Cod. 09205/1KG

Formato: 1 kg

1
U.M.V.

12
Imballo



Colla **vinilica** bianca multiuso, **atossica e lavabile**.
Per carta, tessuto, legno e ceramica.



Cod. 21310/100
Formato: 100 g

Cod. 21310/1KG
Formato: 1 kg



12

U.M.V.



144

Imballo



1

U.M.V.



12

Imballo

Cod. 21310/250
Formato: 250 g



12

U.M.V.



36

Imballo

colla per puzzle

Colla per proteggere i puzzle, **asciugatura rapida**.
120 ml, prodotto atossico.

Cod. 19515



24

U.M.V.



196

Imballo



ARTS & CRAFTS

Colla **trasparente** atossica, **lavabile**, per tutti i lavori
didattici, essiccazione lenta, riposizionabile.
Tubetto da 88 ml.

Cod. 14597



12

U.M.V.



48

Imballo



insta col

Colla **liquida** ad **asciugatura istantanea**, 50 ml.
Espositore da 24 pezzi.

Cod. 19590

1
U.M.V.

288
Imballo



8

Shine glitter glue

METAL E FOSFORESCENTE

Espositore da 12 pezzi, **177 ml**, tappo dosatore per applicazione facilitata.
Prodotto **atossico** e certificato. Confezione da 12 pezzi assortiti.
6 colori metal (**effetto metallizzato**), 6 colori fluorescenti (**brillano al buio**).

Cod. 14595/03

12
U.M.V.

48
Imballo





Shine
glitter glue

CLASSIC

6 colori metallizzati, 177 ml, tappo dosatore per applicazione facilitata. Prodotto **atossico** e certificato. Confezione da 12 pezzi assortiti.

Cod. 14595/01

Cod. 14595/ORO

Cod. 14595/ARG

Cod. 14595/RS



12
U.M.V.

48
Imballo



8

Shine
glitter glue

FLUO

6 colori fluorescenti, 177 ml, tappo dosatore per applicazione facilitata. Prodotto **atossico** e certificato. Confezione da 12 pezzi assortiti.

Cod. 14595/02



12
U.M.V.

48
Imballo



Shine
glitter glue

ULTRA

6 colori con paillettes, 125 ml, tappo dosatore per applicazione facilitata. Prodotto **atossico** e certificato. Confezione da 12 pezzi assortiti.

Cod. 14596



12
U.M.V.

48
Imballo



Shine glitter glue SHINE

Tubetto 12,5 g, tappo dosatore per applicazione facilitata. Prodotto **atossico** e certificato. Confezione in barattolo da 50 pezzi assortiti.

Cod. 39566



1
U.M.V.

4
Imballo



8

Shine glitter GLITTER

Barattolo 50 g a 6 compartimenti con tappo dosatore, espositore 6 pezzi: 3 barattoli colori classici, 3 barattoli colori fluorescenti.

Cod. 55402/01

1
U.M.V.

12
Imballo



Shine glitter FORMINE

Barattolo 50 g a 6 compartimenti con tappo dosatore, espositore 6 pezzi: 3 barattoli colori classici, 3 barattoli colori fluorescenti. Assortimento cuori, fiori, farfalle, stelle.

Cod. 55402/02

1
U.M.V.

12
Imballo





Super GLUE

Adesivo universale istantaneo per incollare cartoncino, ceramica, gomma, legno, metallo, plastica e pelle, **5 g**. Custodia erogatrice salva dita.

Cod. 14606

48
U.M.V.

120
Imballo



TRA·TAK

Gommini adesivi riposizionabili in silicone. Display da 60 pezzi, \varnothing 10 mm o \varnothing 20 mm.

Cod. 14604/10

Diametro: 10

48
U.M.V.

4
Imballo

Cod. 14604/20

Diametro: 20

48
U.M.V.

4
Imballo



PICIKO

Colla a **nastro**, **8,4 mm x 8 mt**, invisibile.

Cod. 55214

12
U.M.V.

120
Imballo





PISTOLA TERMOFUSIONE

Cod. 21490

40 W, ø 11 mm



U.M.V.

Imballo



Cod. 21489

20 W, ø 7 mm



U.M.V.

Imballo



COLLA STICK

Per pistola termofusione ø 11 mm.
Formula ultra trasparente, confezione da 1kg.

Cod. 14601/01



U.M.V.

Imballo



COLLA STICK

Per pistola termofusione ø 7 mm.
Formula ultra trasparente,
blister da 10 pezzi.

Cod. 14601/02



U.M.V.

Imballo



ESPOSITORE COLLE



Cod. 57622/TERRA

 1
U.M.V.

 1
Imballo

Espositore composto da:

GLITTER GLUE SHINE CLASSIC 24 PZ
 GLITTER GLUE SHINE FLUO 12 PZ
 GLITTER GLUE NEON/METAL 24 PZ
 GLITTER GLUE SHINE ULTRA 12 PZ
 GLITTER CLASSIC/NEON DA 1 CONF. DA 6 PZ
 FORMINE CLASSIC/NEON 1 CONF. DA 6 PZ
 COLLA ARTS & CRAFT LIQUIDA 24 PZ
 GLITTER GLUE DA 12,5 GR IN BARATTOLO 3 PZ
 COLLA GELSTIK 10 GR 120 PZ
 COLLA GELSTIK 20 GR 96 PZ
 COLLA GELSTIK 40 GR 72 PZ
 COLLA IZISTIK 15 G 120 PZ
 COLLA LIQUIDA INSTACOL 48 PZ
 COLLA STICK 11 MM PER COLLA A CALDO 2 PZ

COLLA STICK 7 MM PER COLLA A CALDO 12 PZ
 PISTOLA TERMOFUSIONE ø 7 8 PZ
 PISTOLA TERMOFUSIONE ø 11 4 PZ
 COLLA A NASTRO PICIKO 24 PZ
 COLLA VINYL 250 GR 24 PZ
 COLLA VINYL 1 KG 4 PZ
 COLLA VINYL PRONTO 100 G 24 PZ
 COLLA VINYL PRONTO 250 G 8 PZ
 COLLA VINYL PRONTO 1 KG 4 PZ
 GOMMINO TRIATAK 10 MM 48 PZ
 GOMMINO TRIATAK 20 MM 48 PZ
 COLLA SUPER GLUE 12 PZ
 ESPOSITORE IN LEGNO DA TERRA 1 PZ



NASTRO ADESIVO

Da banco. Confezione a torre. 43 micron.

Cod. 02997/33

Formato: 15 x 33
Micron: 43

🛒 10 U.M.V. 📦 600 Imballo

Cod. 26642/33

Formato: 19 x 33
Micron: 43

🛒 8 U.M.V. 📦 480 Imballo

Cod. 11903/33

Formato: 25 x 33
Micron: 43

🛒 6 U.M.V. 📦 360 Imballo

Cod. 02997/66

Formato: 15 x 66
Micron: 43

🛒 10 U.M.V. 📦 240 Imballo

Cod. 26642/66

Formato: 19 x 66
Micron: 43

🛒 8 U.M.V. 📦 192 Imballo

Cod. 11903/66

Formato: 25 x 66
Micron: 43

🛒 6 U.M.V. 📦 144 Imballo



NASTRO ADESIVO CON CHIOCCIOLINA

In plastica trasparente colorata, espositore da 50 pezzi, formato 15 x 10 mt.

Cod. 10756

🛒 50 U.M.V. 📦 200 Imballo



NASTRO ADESIVO

Da **imballaggio**, trasparente, prodotto con PE (polietilene) "low noise", 50 micron.
Da utilizzare su superfici lisce e prive di polvere.

Cod. 23294/50

Formato: 50 x 50
Micron: 50



6

U.M.V.



72

Imballo

Cod. 23294/132

Formato: 50 x 132
Micron: 50



6

U.M.V.



36

Imballo

Cod. 23294/66

Formato: 50 x 66
Micron: 50



6

U.M.V.



72

Imballo

Cod. 23294/200

Formato: 50 x 200
Micron: 50



6

U.M.V.



36

Imballo

NASTRO ADESIVO

Da **imballaggio** avana, prodotto con PE (polietilene) "low noise", 50 micron.
Da utilizzare su superfici lisce e prive di polvere.

Cod. 23295/50

Formato: 50 x 50
Micron: 50



6

U.M.V.



72

Imballo

Cod. 23295/132

Formato: 50 x 132
Micron: 50



6

U.M.V.



36

Imballo

Cod. 23295/66

Formato: 50 x 66
Micron: 50



6

U.M.V.



72

Imballo

Cod. 23295/200

Formato: 50 x 200
Micron: 50



6

U.M.V.



36

Imballo



NASTRO ADESIVO

Colorato 50 micron.

Cod. 23301/50

Formato: 50 x 50



6



36

U.M.V.



36

Imballo

Cod. 55649/RS

Formato: 50 x 66



6



36

U.M.V.



36

Imballo



Cod. 23301/66

Formato: 50 x 66



6

U.M.V.



36

Imballo

Cod. 55649/BL

Formato: 50 x 66



6

U.M.V.



36

Imballo



DISPENSER

Da banco per nastri da **33 mt.**

Cod. 54790



U.M.V.



Imballo

DISPENSER

Per nastro da imballo **50 mm.**

Cod. 54792



U.M.V.



Imballo



DISPENSER

Da banco per nastri da **66 mt.**

Cod. 54791



U.M.V.



Imballo





NASTRO BIADESIVO

110 micron. Inscatolato singolarmente.

Cod. 26643

Formato: 15 x 10



10

U.M.V.



240

Imballo

Cod. 26644

Formato: 50 x 5



1

U.M.V.



36

Imballo

NASTRO BIADESIVO

110 micron. Confezione a torre.

Cod. 23307/15

Formato: 15 x 50



10

U.M.V.



40

Imballo

Cod. 23307/19

Formato: 19 x 50

Cod. 23307/25

Formato: 25 x 50

Cod. 23307/30

Formato: 30 x 50



8

U.M.V.



96

Imballo

Cod. 23307/38

Formato: 38 x 50

Cod. 23307/50

Formato: 50 x 50



6

U.M.V.



36

Imballo



NASTRO BIADESIVO

110 micron, spugnatura 2 mm,
formato 50 x 5 mt, blisteratura singola.

Cod. 26645

Formato: 50 x 5 Mt



1

U.M.V.



12

Imballo



NASTRO ADESIVO

Invisibile, formato **19 x 33 mt.**
Removibile su carta lucida.
Confezione singola blisterata.

Cod. 23319

Formato: 19 x 33

10
U.M.V.

480
Imballo

NASTRO GOMMATO

150 micron. Confezione a torre.

Cod. 23312/15

Formato: 15 x 50

10
U.M.V.

120
Imballo

Cod. 23312/38

Formato: 38 x 50

8
U.M.V.

48
Imballo

Cod. 23312/50

Formato: 50 x 50

6
U.M.V.

36
Imballo

Cod. 23312/19

Formato: 19 x 50

8
U.M.V.

72
Imballo

Cod. 23312/30

Formato: 30 x 50

5
U.M.V.

96
Imballo

Cod. 23312/25

Formato: 25 x 50

6
U.M.V.

72
Imballo



NASTRO ISOLANTE

In pvc, **130 micron**, formato **18 x 10 mt.**
blisterato singolarmente.
Confezione a torre da 8 pezzi.

Cod. 10757/BN

Formato: 18 x 10

8
U.M.V.

240
Imballo

Cod. 10757/NR

Formato: 18 x 10

8
U.M.V.

240
Imballo



NASTRO TELATO

250 micron, formato **50 x 25 mt**,
ideale per la rilegatura.
Ogni rotolo é blisterato singolarmente.

Cod. 54713/BL

Cod. 54713/BN

Cod. 54713/RS

Formato: 50 x 25



8

NASTRO TELATO

250 micron, formato **38 x 25 mt**,
ideale per la rilegatura.
Ogni rotolo é blisterato singolarmente.

Cod. 23318/BL

Cod. 23318/BN

Cod. 23318/GL

Cod. 23318/NR

Cod. 23318/RS

Cod. 23318/VR

Formato: 38 x 25



NASTRO DEMARCAZIONE

Nastro adesivo in **PVC** giallo/nero, per demarcazione,
calpestabile, **150 micron**.
Formato **50 x 25 mt**. Blisteratura singola.

Cod. 55648

Formato: 50 x 25





SPILABELS

Etichette autoadesive multiuso **pretagliate**, buste da 10 fogli.

Cod. 19784/01 Formato: 34 x 5	Cod. 19784/07 Formato: 73 x 37	Cod. 19784/04 Formato: 58 x 27	Cod. 19784/10 Formato: 110 x 34
Cod. 19784/02 Formato: 56 x 10	Cod. 19784/08 Formato: 70 x 56	Cod. 19784/05 Formato: 58 x 34	Cod. 19784/11 Formato: 110 x 46
Cod. 19784/03 Formato: 46 x 27	Cod. 19784/09 Formato: 83 x 53	Cod. 19784/06 Formato: 70 x 27	Cod. 19784/12 Formato: 115 x 70

 10
U.M.V.

 25
Imballo



ESPOSITORE *Spilabels*

Espositore etichette da banco in cartone 300 pezzi,
25 pezzi per modello.

Cod. 19784/ESP

Formato: 34 x 5

1
U.M.V.

1
Imballo

LABELS ETICHETTE SENZA MARGINI:

8

Cod.	Dimensioni	Etichette per confezione
Cod. 08160/01	210 x 297	100
Cod. 08160/02	210 x 148	200
Cod. 08160/04	105 x 297	200
Cod. 08160/05	210 x 99	300
Cod. 08160/06	70 x 297	300
Cod. 08160/07	105 x 148	400
Cod. 08160/10	40 x 297	500
Cod. 08160/11	105 x 99	600
Cod. 08160/14	105 x 74	800
Cod. 08160/17	210 x 37	800
Cod. 08160/19	105 x 59	1000
Cod. 08160/24	210 x 25	1200
Cod. 08160/25	105 x 42,3	1400
Cod. 08160/28	52,5 x 72	1600
Cod. 08160/29	105 x 37	1600
Cod. 08160/35	70 x 42,3	2100
Cod. 08160/38	70 x 36	2400
Cod. 08160/40	70 x 37	2400
Cod. 08160/41	105 x 25	2400
Cod. 08160/44	35 x 59	3000
Cod. 08160/45	70 x 29,7	3000
Cod. 08160/47	52,5 x 37	3200
Cod. 08160/49	70 x 24,7	3600
Cod. 08160/50	52,5 x 29,7	4000
Cod. 08160/54	52,5 x 21,2	5600
Cod. 08160/66	46 x 11,1	8400
Cod. 08160/77	70 x 148	600

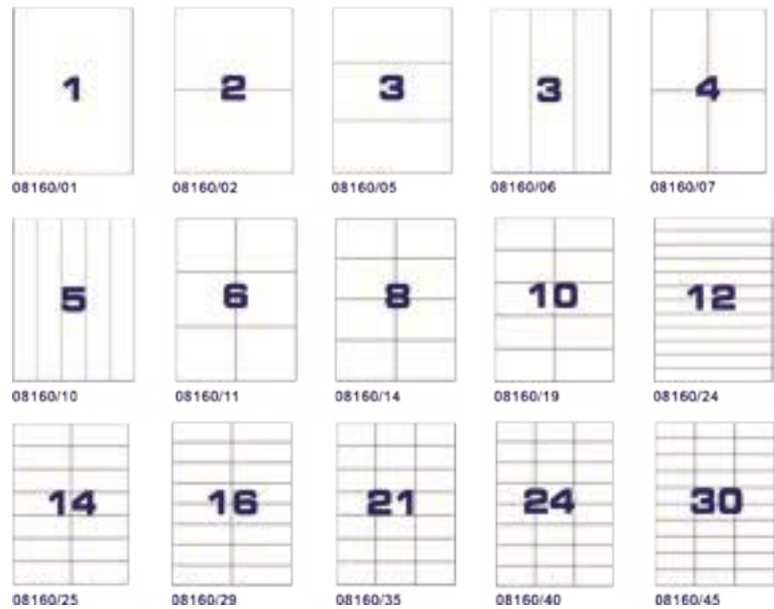

1 U.M.V.

10 Imballo

LABELS ETICHETTE CON MARGINI:

Cod.	Dimensioni	Etichette per confezione
Cod. 08160/08	105 x 140	400
Cod. 08160/15	105 x 72	800
Cod. 08160/16	105 x 70	800
Cod. 08160/20	105 x 57	1000
Cod. 08160/21	105 x 48	1200
Cod. 08160/22	101 x 48	1200
Cod. 08160/27	70 x 50,8	1500
Cod. 08160/30	105 x 36	1600
Cod. 08160/33	70 x 48	1800
Cod. 08160/36	70 x 41	2100
Cod. 08160/39	70 x 35	2400
Cod. 08160/53	70 x 16,9	5100
Cod. 08160/57	48,5 x 16,9	6400
Cod. 08160/58	38 x 21,2	6500
Cod. 08160/59	35 x 23,5	7200
Cod. 08160/64	ø 40	2400
Cod. 08160/71	67 x 10	8400
Cod. 08160/72	70 x 40	2100
Cod. 08160/74	70 x 67	1200
Cod. 08160/76	70 x 72	1200
Cod. 08160/86	210 x 48	600
Cod. 08160/87	210 x 128	200
Cod. 08160/88	ø 20	8800
Cod. 08160/89	ø 26	7000
Cod. 08160/90	ø 60	1200

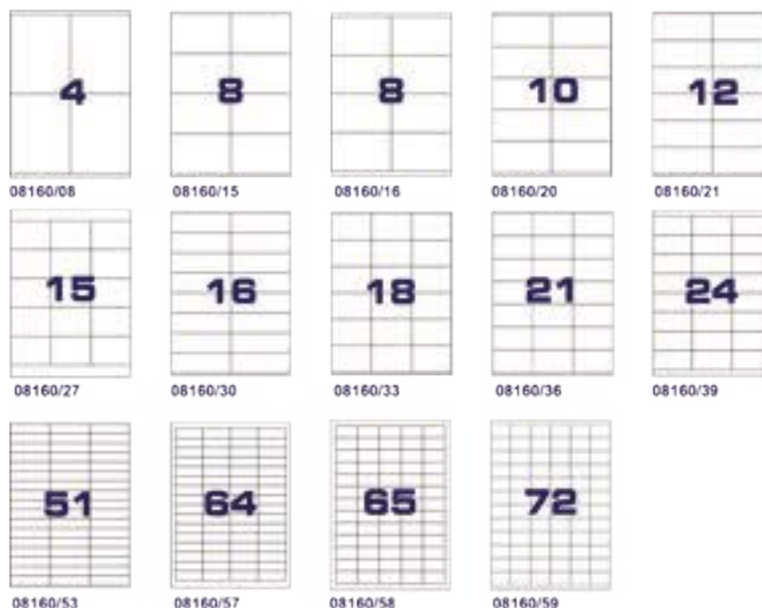

LABELS ETICHETTE CON ANGOLI:

8

Cod.	Dimensioni	Etichette per confezione
Cod. 08160/03	200 x 142	200
Cod. 08160/09	190 x 61	400
Cod. 08160/12	99,1 x 93,1	600
Cod. 08160/13	190 x 38	700
Cod. 08160/18	99,1 x 67,7	800
Cod. 08160/23	97 x 42,3	1200
Cod. 08160/26	99,1 x 38,1	1400
Cod. 08160/32	99,1 x 34	1600
Cod. 08160/34	63,5 x 46,6	1800
Cod. 08160/37	63,5 x 38,1	2100
Cod. 08160/42	64,6 x 33,8	2400
Cod. 08160/46	47,5 x 35	3200
Cod. 08160/51	48,5 x 25,4	4000
Cod. 08160/52	47,5 x 25,5	4400
Cod. 08160/56	37,5 x 23,5	6000
Cod. 08160/60	37 x 14	10000
Cod. 08160/65	22 x 12,7	4800
Cod. 08160/67	47,5 x 46,5	2400
Cod. 08160/68	47,7 x 70	1600
Cod. 08160/69	56 x 28	2700
Cod. 08160/70	63,5 x 72	1200
Cod. 08160/73	70 x 52	1000
Cod. 08160/75	70 x 70	800
Cod. 08160/78	76,2 x 46,4	1200
Cod. 08160/79	99,1 x 139	400
Cod. 08160/80	99,1 x 142	400
Cod. 08160/81	99,6 x 57	1000
Cod. 08160/82	15 x 140	2600
Cod. 08160/83	145 x 17	1700
Cod. 08160/84	199,6 x 143,5	200
Cod. 08160/85	199,6 x 289,1	100

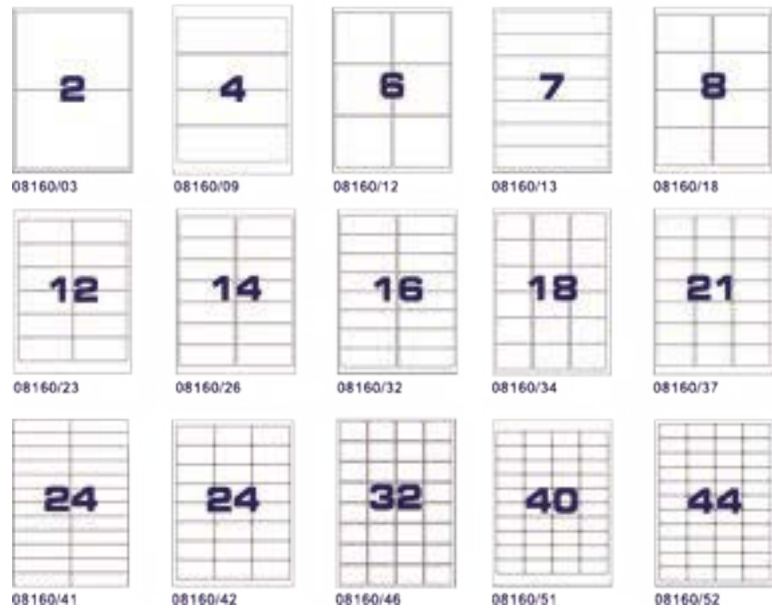

1 U.M.V.

10 Imballo



LABELS ETICHETTE ADESIVE

Formato **A4**, effetto **lucido**.

Cod.	Dimensioni	Etichette per confezione	Effetto
Cod. 54592	A4	70	Lucido

 1
U.M.V.

 10
Imballo



PREZZATRICE

26 x 12 ad 1 linea da 8 caratteri.

Kit vendita composta da:

1 prezzatrice, 10 rotoli e un tampone di ricambio.

Cod. 28188

26 x 12



PREZZATRICE

21 x 12 ad 1 linea da 8 caratteri.

Kit vendita composta da:

1 prezzatrice, 10 rotoli e un tampone di ricambio.

Cod. 28189

21 x 12



PREZZATRICE

26 x 16 a 2 linee da 8 caratteri.

Kit vendita composta da:

1 prezzatrice, 10 rotoli e un tampone di ricambio.

Cod. 28190

26 x 16

26 x 16



PREZZATRICE

26 x 12 a 2 linee da 8 caratteri con cliché.

Kit vendita composta da:

1 prezzatrice, 10 rotoli, un tampone di ricambio e nr. 3 cliché.

Cod. 28191

26 x 12



TAMPONE PER PREZZATRICI

Tampone compatibile per ogni modello di prezzatrice Spil: **21x12 - 26x12 - 26x16**

Cod. 00364

1
U.M.V.

100
Imballo



8

ETICHETTE PER PREZZATRICI

Cod.	Formato	Modello	Variazione
Cod. 28192/OBP	26 x 12		Permanente
Cod. 28192/OBR	26 x 12		Removibile
Cod. 28192/OCPAR	26 x 12		Permanente
Cod. 28192/OCPFC	26 x 12		Permanente
Cod. 28192/OCPGL	26 x 12		Permanente
Cod. 28192/OCPRS	26 x 12		Permanente
Cod. 28192/OCPVR	26 x 12		Permanente
Cod. 28192/OCRAR	26 x 12		Removibile
Cod. 28192/OCRGL	26 x 12		Removibile
Cod. 28193/RBP	26 x 16		Permanente
Cod. 28193/OBP	26 x 16		Permanente
Cod. 28193/OPGL	26 x 16		Permanente
Cod. 28193/OPAR	26 x 16		Permanente
Cod. 28193/OPRS	26 x 16		Permanente
Cod. 28193/OCPVR	26 x 16		Permanente

Cod.	Formato	Modello	Variazione
Cod. 28195/RLP	21 x 12		Permanente
Cod. 28195/RLR	21 x 12		Removibile
Cod. 28195/RPAR	21 x 12		Permanente
Cod. 28195/RPGL	21 x 12		Permanente
Cod. 28195/RPRS	21 x 12		Permanente

50
U.M.V.

200
Imballo



36
U.M.V.

144
Imballo

L'imbollo perfetto con Spil!



IMBALLAGGIO

PLURIBALL.....	170
FILM ESTENSIBILE.....	170
CARTA DA IMBALLO.....	171

PLURIBALL

Bobina in polietilene con bolle d'aria per imballaggio.

Cod. 15180/5

Formato: 1 x 5 mt
Grammatura: 140

Cod. 15180/10

Formato: 1 x 10 mt
Grammatura: 140

Cod. 15180/100

Formato: 1 x 100 mt
Grammatura: 140

Cod. 15181/5

Formato: 1 x 5 mt
Grammatura: 50

Cod. 15181/10

Formato: 1 x 10 mt
Grammatura: 50

Cod. 15181/100

Formato: 1 x 100 mt
Grammatura: 50

 1
U.M.V.

 20
Imballo

 1
U.M.V.

 10
Imballo

 1
U.M.V.

 1
Imballo



FILM ESTENSIBILE

Bobina in PVC, 2,6 kg, H. 49 cm.

Ideale per sigillare in modo rapido e sicuro.

Cod. 07168/NT

Colore: Neutro

Cod. 07168/NR

Colore: Nero

Cod. 07168/AZ

Colore: Azzurro

Cod. 07168/BN

Colore: Bianco

 1
U.M.V.

 6
Imballo

CARTA DA IMBALLO

Formato **100 x 140 cm**,
50 fogli piegati, colore bianco/avana.

Cod. 14750/AV

Cod. 14750/BN

Modello: Avana 80 g **Modello: Bianca 80 g**

 50
 U.M.V.

 250
 Imballo

 50
 U.M.V.

 250
 Imballo

Cod. 14750/31

Modello: Bianca 31 g

 100
 U.M.V.

 500
 Imballo



CARTA DA IMBALLO

Formato **100 x 140 cm**, balledda **5 kg**,
 colore bianco/avana.

Cod. 57621

Cod. 57621/BN

Modello: Avana 80 g

Modello: Bianca 80 g

 5 kg
 U.M.V.

 5 kg
 Imballo

 5 kg
 U.M.V.

 5 kg
 Imballo

SPIL LASCIA IL SEGNO!

Cubotti e Stiki Memo

BLOCCHI NUMERATI	174
PLANNING	174
Q.BO	174
SEGNA PAGINE	175
STIKI MEMO	176

10

BLOCCO NUMERATO

Blocco numerato **1-100** con **fogli staccabili**.
Disponibile in confezione da **50 pezzi** o in display da banco.

Cod. 03919

 50 U.M.V.  250 Imballo



PLANNING SETTIMANALE

Planning settimanale da tavolo,
formato **30 x 42 cm**, **52 fogli da 80 g/m²**.

Cod. 54464

 1 U.M.V.  50 Imballo



Q·BO FORTI

Cubotto di carta, colori forti, **80 g/m²**,
formato **9 x 9 cm**, 700 fogli.

Cod. 00904/FT

 5 U.M.V.  25 Imballo



Q·BO BIANCO

Cubotto di carta bianca, **80 g/m²**,
formato **9 x 9 cm**, 700 fogli.

Cod. 00904/BN

 5 U.M.V.  25 Imballo



Q·BO TENUI

Cubotto di carta, colori tenui, **80 g/m²**,
formato **9 x 9 cm**, 700 fogli.

Cod. 00904/TN

 5 U.M.V.  25 Imballo



STIKI MEMO INDEX

Segnapagine **in carta**, formato **15 x 50 mm**.
100 fogli in 5 colori.

Cod. 55416

24
U.M.V.

432
Imballo



STIKI MEMO INDEX

Segnapagine **in carta**, formato **25 x 76 mm**.
100 fogli in 3 colori.

Cod. 55417

24
U.M.V.

576
Imballo



STIKI MEMO INDEX

Segnapagine **in PPL**, formato **12 x 45 mm**.
100 fogli in 5 colori.

Cod. 55422

30
U.M.V.

432
Imballo



STIKI MEMO INDEX

Segnapagine **in PPL**, formato **12 x 45 mm**.
100 fogli in 5 colori.

Cod. 55415

30
U.M.V.

540
Imballo



STIKI MEMO INDEX

Cubotto di foglietti adesivi colori fluorescenti, formato **75 x 75 mm**, 400 fogli.

Cod. 11389

Colori: Fluo



6

U.M.V.



12

Imballo



STIKI MEMO INDEX

Cubotto di foglietti adesivi, formato **50 x 50 mm**, colori fluorescenti, 250 fogli.

Cod. 55419



12

U.M.V.



324

Imballo



STIKI MEMO INDEX

Foglietti adesivi rigati, formato **100 x 150 mm**.
100 fogli, colore giallo pastello.

Cod. 55418



6

U.M.V.



216

Imballo



STIKI MEMO FLUO

Foglietti adesivi, 4 colori fluorescenti.
Blocchetti da 100 fogli.

Cod. 22392/AR	Cod. 22397/AR	Cod. 22400/AR
Cod. 22392/GL	Cod. 22397/GL	Cod. 22400/GL
Cod. 22392/MG	Cod. 22397/MG	Cod. 22400/MG
Cod. 22392/VR	Cod. 22397/VR	Cod. 22400/VR

Formato: 40 x 50 Formato: 75 x 75 Formato: 75 x 125

36 U.M.V.	288 Imballo	12 U.M.V.	384 Imballo	12 U.M.V.	288 Imballo
--------------	----------------	--------------	----------------	--------------	----------------



STIKI MEMO PASTEL

Foglietti adesivi, 4 colori pastello. Blocchetti da 100 fogli.

Cod. 22391/GL	Cod. 22396/GL	Cod. 22399/GL
Cod. 22391/VR	Cod. 22396/VR	Cod. 22399/VR
Cod. 22391/RO	Cod. 22396/RO	Cod. 22399/RO
Cod. 22391/BL	Cod. 22396/BL	Cod. 22399/BL

Formato: 40 x 50 Formato: 75 x 75 Formato: 75 x 125

36 U.M.V.	288 Imballo	12 U.M.V.	384 Imballo	12 U.M.V.	288 Imballo
--------------	----------------	--------------	----------------	--------------	----------------

Formato: 40 x 50

Formato: 75 x 75

Formato: 75 x 125



10



STIKI MEMO FUN

Display da 50 pezzi assortiti, segnapagine in carta adesiva, 5 modelli formato 15 x 45 mm da 125 fogli.

Cod. 22406/ESP

1
U.M.V.

14
Imballo



FANTASIE ASSORTITE



Buste 5 Stiki
da 25
segnapagina
fantasia
cadauna.

STIKI MEMO

Display da 299 pezzi assortiti, composto da notes adesivi **riposizionabili**, segnapagine in film e carta adesiva.

Cod. 20308

1
U.M.V.

2
Imballo



STIKI MEMO SHAPES

Display da 42 pezzi assortiti, formato **75 x 75 mm**, notes adesivi **riposizionabili** da 100 foglietti.

Cod. 22370

1
U.M.V.

8
Imballo

FANTASIE ASSORTITE



Spil: precisione in ogni punto!



Spillatrici e Accessori

SPILLATRICI.....	182
PUNTI PER SPILLATRICI.....	185
LEVAPUNTI.....	186
PERFORATORI.....	187
FORBICI.....	188
CUTTER.....	189
FERMAGLI.....	190
PUNTINE.....	190
SPILLI CARTOGRAFICI.....	191
BINDER CLIP.....	191
UMIDIFICATORE.....	191



LA SPILLATRICE

Cucitrice a pinza, impugnatura ergonomica, **punti 6/4**, base girevole per punti aperti o chiusi.
 Cuce fino a **15 fogli** 80 g/m.
 Colori assortiti. In scatole singole. Espositore 12 pezzi assortiti.

Cod. 15953

Capacità di perforazione: 15 fogli



12
U.M.V.

60
Imballo





LA MINI SPILLATRICE

Mini cucitrice tascabile, 6 colori, per **punti numero 10**.
Espositore da 12 pezzi assortiti.



Cod. 16232

Capacità di perforazione: 10 fogli



12
U.M.V.

120
Imballo

LA SPILLATRICE XL

Cucitrice a pinza, in metallo, per **punti numero 24/6 e 24/8**, spilla fino a **40 fogli**, finitura cromata o nera.

Cod. 15954

Capacità di perforazione: 40 fogli



6
U.M.V.

60
Imballo



CUCITRICE A BRACCIO LUNGO

Cucitrice a braccio lungo, punti **24/6** e **24/8**, base girevole per punti aperti e chiusi.

Cod. 16233

Capacità di perforazione: 20 fogli

 12
U.M.V.

 48
Imballo



11

CUCITRICE ALTI SPESSORI

Cucitrice alti spessori, per punti da **23/6** a **23/24**, sforzo ridotto.

Cod. 15955

Capacità di perforazione: 240 fogli

 1
U.M.V.

 6
Imballo



PUNTI PER SPILLATRICE

In multi-wire per una migliore penetrazione e tenuta.
Confezione da **2000 punti**.



Cod. 55655
Dimensione: 6/4

1
U.M.V.

300
Imballo

PUNTI PER SPILLATRICE

In multi-wire per una migliore penetrazione e tenuta.
Confezione da **1000 punti**.

Cod.	Modello	Capacità di perforazione
Cod. 16237	N. 10	8

10
U.M.V.

100
Imballo

Cod.	Modello	Capacità di perforazione
Cod. 16238/6	24/6	20

10
U.M.V.

50
Imballo

Cod.	Modello	Capacità di perforazione
Cod. 16239/6	23/6	30
Cod. 16239/8	23/8	40
Cod. 16239/10	23/10	70
Cod. 16239/13	23/13	100
Cod. 16239/15	23/15	120
Cod. 16239/17	23/17	140
Cod. 16239/20	23/20	170
Cod. 16239/24	23/24	210

1
U.M.V.

10
Imballo





11

LEVAPUNTI

A pinza in **metallo**.

Cod. 54788

 12
U.M.V.

 48
Imballo



PERFORATORE

A pinza, **1 foro**, in **metallo**.

Cod. 54789

 6
U.M.V.

 24
Imballo





PERFORATORE

In metallo, **2 fori**, con guida regolabile.

Cod. 22559



Capacità di perforazione: 30 fogli



U.M.V.



Imballo



PERFORATORE

In metallo, **4 fori**, regolabile.

Cod. 16231

Capacità di perforazione: 15 fogli



U.M.V.



Imballo



FORBICI "BASIC"

Impugnatura ergonomica, lama in acciaio.
 Confezionate singolarmente in blister appendibile.

Cod. 15196/17

Lunghezza: 17 cm

Cod. 15196/21

Lunghezza: 21 cm

Cod. 15196/23

Lunghezza: 23 cm

 12
 U.M.V.

 48
 Imballo



11

FORBICI "SOFT"

Impugnatura morbida gommata, lama in acciaio.
 Confezionate singolarmente in blister appendibile.

Cod. 15195/19

Lunghezza: 19 cm

Cod. 15195/21

Lunghezza: 21,5 cm

Cod. 15195/23

Lunghezza: 23 cm

 12
 U.M.V.

 48
 Imballo





CUTTER

Impugnatura in plastica, **lama in acciaio** con blocco.

Cod. 54644/09
Lama: 9 mm

Cod. 54644/18
Lama: 18 mm

50
U.M.V.

200
Imballo

30
U.M.V.

120
Imballo

CUTTER

Impugnatura in alluminio, **lama in acciaio** con blocco.
Blisteratura singola appendibile.

Cod. 54645/09
Lama: 9 mm

Cod. 54645/18
Lama: 18 mm

12
U.M.V.

144
Imballo



LAMA DI RICAMBIO

In acciaio per cutter,
confezione da **10 pezzi**, appendibile.

Cod. 54646/09
Lama: 9 mm

Cod. 54646/18
Lama: 18 mm

40
U.M.V.

160
Imballo

20
U.M.V.

80
Imballo



FERMAGLI

In metallo zincato, confezione da 100 pezzi.

Cod. 55651/28

N.3

10
U.M.V.

500
Imballo

Cod. 55651/50

N.5

10
U.M.V.

200
Imballo

Cod. 55651/36

N.4

10
U.M.V.

300
Imballo

Cod. 55651/60

N.6

10
U.M.V.

200
Imballo

11

PUNTINE

In acciaio INOX, 100 pezzi, in astuccio appendibile.

Cod. 55033

24
U.M.V.

24
Imballo



PUNTINE

In acciaio, teste colorate, confezione da 100 pezzi, in astuccio appendibile.

Cod. 55034

24
U.M.V.

24
Imballo





SPILLI CARTOGRAFICI

Confezione da **100 pezzi**, 5 colori,
in astuccio appendibile.

Cod. 55035

🛒 24
U.M.V.

📦 24
Imballo

BINDER CLIP

In **metallo**, confezioni da **12 pezzi**.

Cod. 55662/19

Dimensione: 19 mm

🛒 1
U.M.V.

📦 300
Imballo

Cod. 55662/51

Dimensione: 51 mm

🛒 1
U.M.V.

📦 60
Imballo

Cod. 55662/32

Dimensione: 32 mm

🛒 1
U.M.V.

📦 120
Imballo



UMIDIFICATORE PER DITA

Umidificante **40 g.**

Cod. 19529

🛒 96
U.M.V.

📦 8
Imballo



Personalizza il tuo mondo con Spil!

12

Accessori

CARTELLI VARI.....	194
CARTELLI SEGNA PREZZO.....	195
ELASTICI.....	197
PORTA BLOCCHI.....	198
ELIMINA CODE.....	200
REGGI LIBRI.....	202
PREZZATRICI.....	203
UMIDIFICATORE.....	205

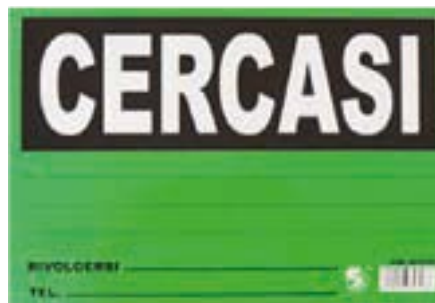

CARTELLI

Formato 23 x 35 cm, in confezioni da 25 pezzi.

Cod. 26747/01
Modello: Vendesi

Cod. 26747/03
Modello: Cercasi

Cod. 26747/05
Modello: Chiuso per ferie

Cod. 26747/07
Modello: Divieto di sosta

Cod. 26747/02
Modello: Affittasi

Cod. 26747/04
Modello: Orario

Cod. 26747/06
Modello: Saldi

Cod. 26747/08
Modello: Vietato fumare

Cod. 26747/09
Modello: Video sorveglianza

25
UMV.

100
Imballo

SEGNAPREZZI PICCOLI

Cartoncino fluo, misura **8 x 5 cm.**
 Confezione da **50 pezzi** in colori assortiti.

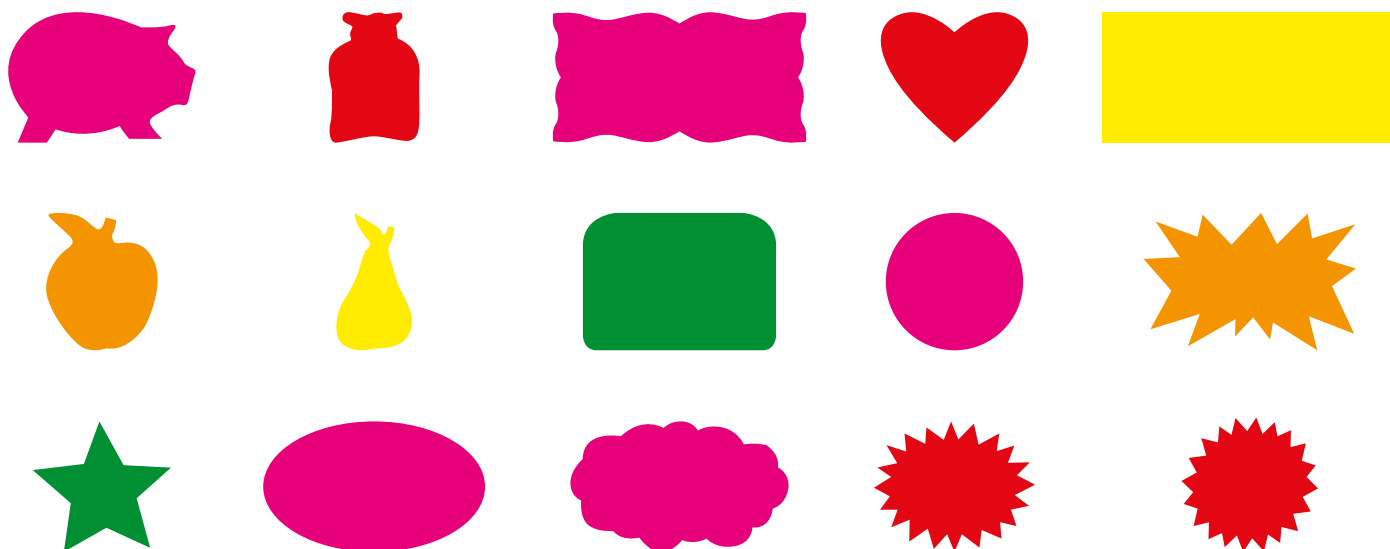

Cod.	Modello
Cod. 11393/01	
Cod. 11393/02	
Cod. 11393/03	
Cod. 11393/04	
Cod. 11393/05	
Cod. 11393/06	
Cod. 11393/07	

1 U.M.V.
 10 Imballo

Cod.	Modello
Cod. 11393/08	
Cod. 11393/09	
Cod. 11393/10	
Cod. 11393/11	
Cod. 11393/12	
Cod. 11393/13	
Cod. 11393/14	
Cod. 11393/15	







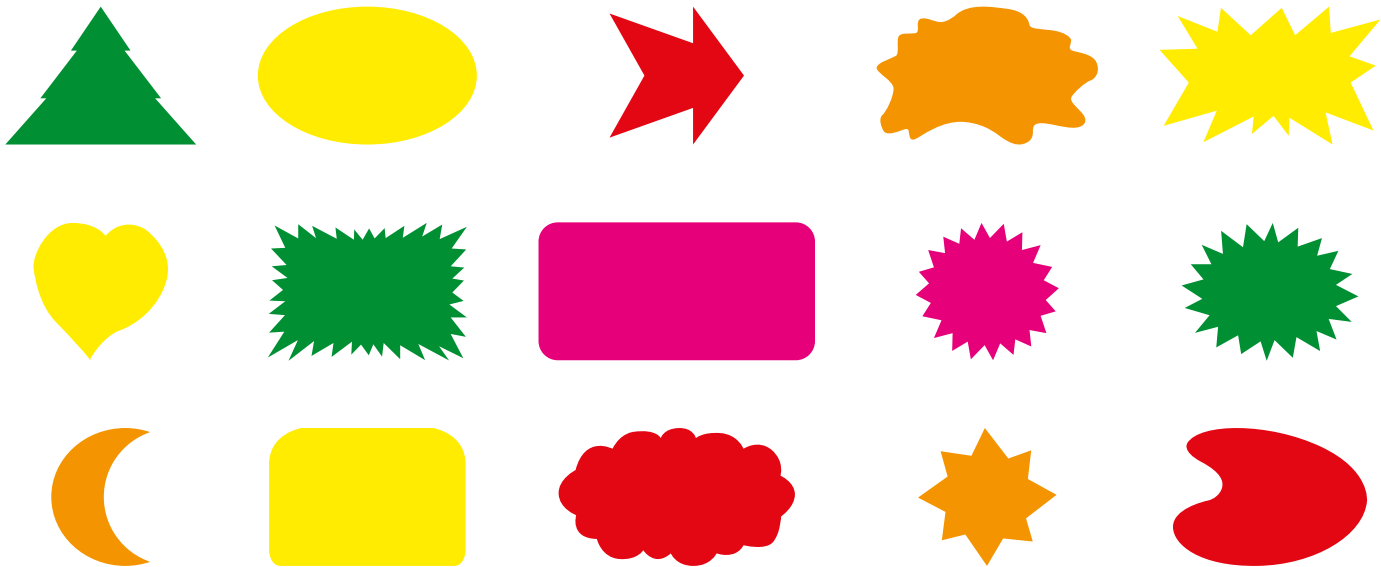

1 U.M.V.
 10 Imballo







SEGNAPREZZI MEDI

Cartoncino fluo, misura **11 x 7 cm.**
 Confezione da **50 pezzi** in colori assortiti.



12

Cod.	Modello
<input type="text" value="Cod. 11394/01"/>	
<input type="text" value="Cod. 11394/02"/>	
<input type="text" value="Cod. 11394/03"/>	
<input type="text" value="Cod. 11394/04"/>	
<input type="text" value="Cod. 11394/05"/>	
<input type="text" value="Cod. 11394/06"/>	
<input type="text" value="Cod. 11394/07"/>	
<input type="text" value="Cod. 11394/08"/>	

Cod.	Modello
<input type="text" value="Cod. 11394/09"/>	
<input type="text" value="Cod. 11394/10"/>	
<input type="text" value="Cod. 11394/11"/>	
<input type="text" value="Cod. 11394/12"/>	
<input type="text" value="Cod. 11394/13"/>	
<input type="text" value="Cod. 11394/14"/>	
<input type="text" value="Cod. 11394/15"/>	

 1
U.M.V.







 10
Imballo

 1
U.M.V.

 10
Imballo

SEGNAPREZZI GRANDI

Cartoncino fluo, misura **23 x 13 cm.**
 Confezione da **50 pezzi** in colori assortiti.

Cod.	Modello
Cod. 11395/01	
Cod. 11395/02	
Cod. 11395/03	
Cod. 11395/04	
Cod. 11395/05	
Cod. 11395/06	

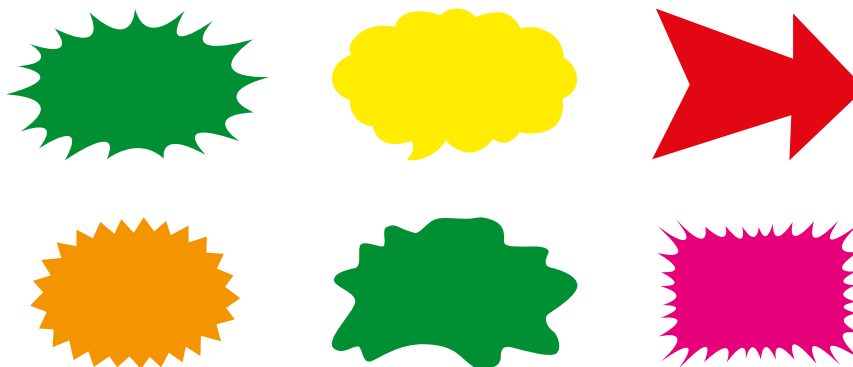

ELASTICI

Elastici assortiti per diametro e colore in bustina da **100 gr.**

Cod. 55924/100



PORTABLOCCO

Formato **23 x 32 cm**, in cartone rivestito,
1 **anta**, mollettone fermacarte.

Cod. 19708/NR

Cod. 19708/BL

Cod. 19708/RS

6
U.M.V.

60
Imballo



12



PORTABLOCCO

Formato **23 x 32 cm**, in cartone rivestito, **2 ante**,
tasca interna, mollettone fermacarte.

Cod. 19709/NR

Cod. 19709/BL

Cod. 19709/RS

6
U.M.V.

60
Imballo



PORTABLOCCO

Formato **23 x 32 cm**, **2 ante**, tasca interna, con clip,
dorso 1 cm, mollettone fermacarte.

Cod. 55929/NR

Cod. 55929/BL

12
U.M.V.

48
Imballo





PORTABLOCCO

Formato **23 x 32 cm**, in plastica rigida, **1 anta**, tavoletta 3 mm, colori fluorescenti, mollettone fermacarte.

Cod. 19685



12 U.M.V.

72 Imballo

Centimetri



Pollici

PORTABLOCCO

Formato **23 x 32 cm**, **1 anta**, tavoletta in MDF 3 mm.

Cod. 55928

12 U.M.V.

72 Imballo

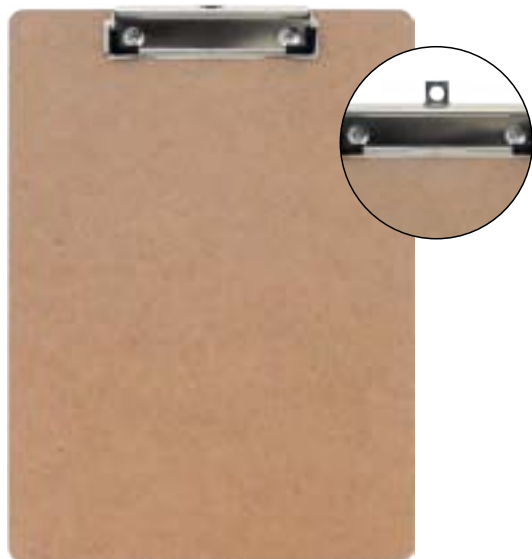



DISPLAY LED A 2 CIFRE PER ELIMINACODE

Cod. 11601



12

TELECOMANDO PER DISPLAY ELIMINACODE

Cod. 11602



DISPENSER PER ETICHETTE ELIMINACODE

400 fogli.

Cod. 11604



ETICHETTE PER ELIMINACODE

Con lettera e 2 numeri,
confezione da 5 rotoli da 2000 ticket.



Cod. 11605

1
U.M.V.

5
Imballo

KIT ELIMINACODE

Piantana e dispenser.

Cod. 11603

1
U.M.V.

1
Imballo



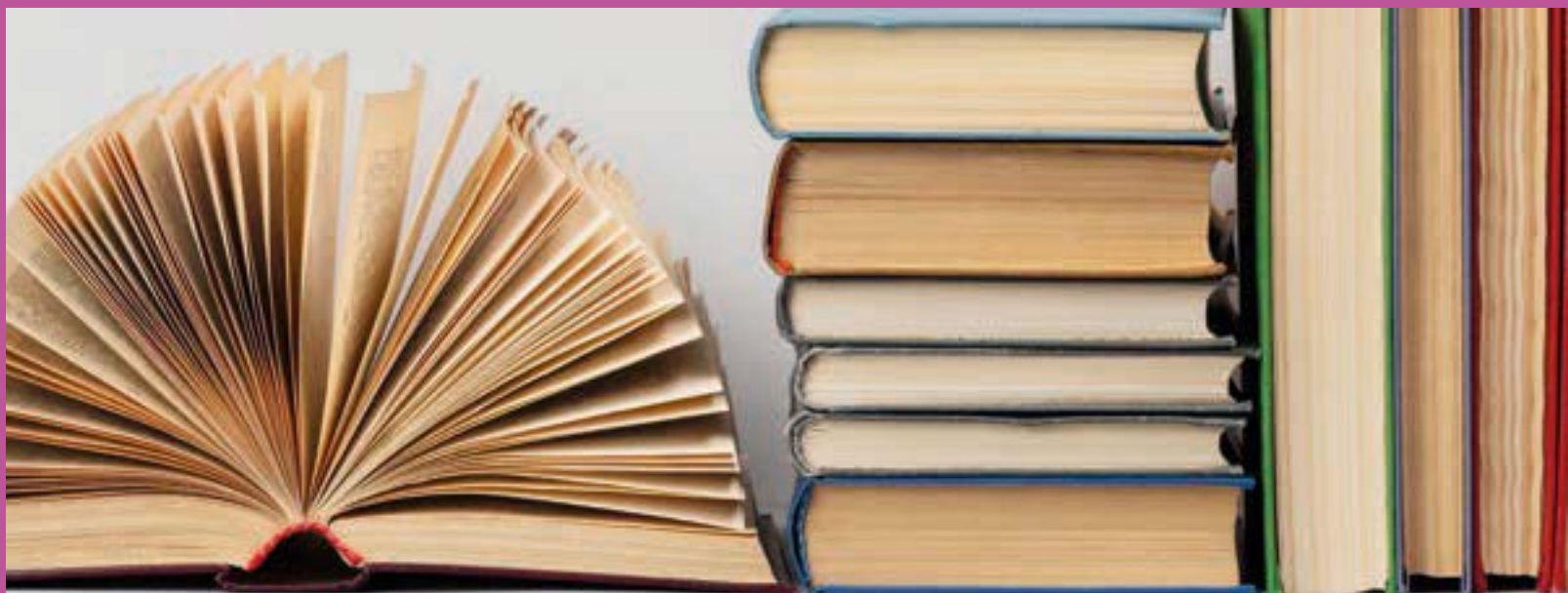

COPPIA REGGILIBRO

12

In metallo verniciato, H. 22 cm.

Cod. 55931/01

 12
U.M.V.

 36
Imballo



COPPIA REGGILIBRO

In metallo, H.19 cm.

Cod. 55931/02

 12
U.M.V.

 36
Imballo



PREZZATRICE

26 x 12 ad 1 linea da 8 caratteri.

Kit vendita composta da:

1 prezzatrice, 10 rotoli e un tampone di ricambio.

Cod. 28188

26 x 12



PREZZATRICE

21 x 12 ad 1 linea da 8 caratteri.

Kit vendita composta da:

1 prezzatrice, 10 rotoli e un tampone di ricambio.

Cod. 28189

21 x 12



12

PREZZATRICE

26 x 16 a 2 linee da 8 caratteri.

Kit vendita composta da:

1 prezzatrice, 10 rotoli e un tampone di ricambio.

Cod. 28190

26 x 16

26 x 16



PREZZATRICE

26 x 12 a 2 linee da 8 caratteri con cliché.

Kit vendita composta da:

1 prezzatrice, 10 rotoli, un tampone di ricambio e nr. 3 cliché.

Cod. 28191

26 x 12



TAMPONE PER PREZZATRICI

Tampone compatibile per ogni modello di prezzatrice Spil: **21x12 - 26x12 - 26x16**

Cod. 00364



1

U.M.V.



100

Imballo



ETICHETTE PER PREZZATRICI

Cod.	Formato	Modello	Variazione
Cod. 28192/OBP	26 x 12		Permanente
Cod. 28192/OBR	26 x 12		Removibile
Cod. 28192/OCPAR	26 x 12		Permanente
Cod. 28192/OCPFC	26 x 12		Permanente
Cod. 28192/OCPGL	26 x 12		Permanente
Cod. 28192/OCPRS	26 x 12		Permanente
Cod. 28192/OCPVR	26 x 12		Permanente
Cod. 28192/OCRAR	26 x 12		Removibile
Cod. 28192/OCRGL	26 x 12		Removibile
Cod. 28193/RBP	26 x 16		Permanente
Cod. 28193/OBP	26 x 16		Permanente
Cod. 28193/OPGL	26 x 16		Permanente
Cod. 28193/OPAR	26 x 16		Permanente
Cod. 28193/OPRS	26 x 16		Permanente
Cod. 28193/OCPVR	26 x 16		Permanente

Cod.	Formato	Modello	Variazione
Cod. 28195/RLP	21 x 12		Permanente
Cod. 28195/RLR	21 x 12		Removibile
Cod. 28195/RPAR	21 x 12		Permanente
Cod. 28195/RPGL	21 x 12		Permanente
Cod. 28195/RPRS	21 x 12		Permanente



50

U.M.V.



200

Imballo



36

U.M.V.



144

Imballo

UMIDIFICATORE PER DITA

Umidificante **40 g.**

Cod. 19529

96
U.M.V.

8
Imballo



12



Archivia con Spil!



PRODUZIONE
PER

CONTRO

OGGETTO

MANDATO

INVOCATO

Archivio

PORTA PROGETTO	208
CARTELLE ELASTICO	210
CARTELLE A SCOMPARTI	213
CARTELLE CON LEMBI	214
CARTELLE SENZA LEMBI	215
CARTELLE CON FINESTRA	215
CARTELLE PRODUZIONE	215
CARTELLE CON ANELLI	216
BUSTE CON FORATURA UNIVERSALE	220
BUSTE TRASPARENTI AD L	221
DIVISORI ED INTERCALARI	221
BUSTE CON BOTTONE	222
BUSTE CON ZIP	224
PORTA TESINA	226
PORTA LISTINI	226
PORTA DOCUMENTI ITALY	228
PORTA DOCUMENTI CLASSIC	229
CARTELLE CON LEGACCIO	230
CARTELLE SOSPESSE	231



CARTELLA PORTAPROGETTO CON ELASTICO

Cartella portaprogetto **con elastico** in cartone rivestito opaco, prodotto blisterato singolarmente

- Cod. 11173/BL**
Dorso: 3
- Cod. 11173/GL**
Dorso: 3
- Cod. 11173/NR**
Dorso: 3
- Cod. 11173/RS**
Dorso: 3
- Cod. 11173/VR**
Dorso: 3

 1 U.M.V.  20 Imballo

- Cod. 11174/BL**
Dorso: 6
- Cod. 11174/GL**
Dorso: 6
- Cod. 11174/NR**
Dorso: 6
- Cod. 11174/RS**
Dorso: 6
- Cod. 11174/VR**
Dorso: 6

 1 U.M.V.  16 Imballo

- Cod. 11175/BL**
Dorso: 8
- Cod. 11175/GL**
Dorso: 8
- Cod. 11175/NR**
Dorso: 8
- Cod. 11175/RS**
Dorso: 8
- Cod. 11175/VR**
Dorso: 8

 1 U.M.V.  12 Imballo

- Cod. 11176/BL**
Dorso: 10
- Cod. 11176/GL**
Dorso: 10
- Cod. 11176/NR**
Dorso: 10
- Cod. 11176/RS**
Dorso: 10
- Cod. 11176/VR**
Dorso: 10

 1 U.M.V.  10 Imballo



CARTELLA PORTAPROGETTO CON BOTTONE

Cartella portaprogetto **con bottone** in cartone rivestito lucido formato 23 x 35 cm, con etichette interne adesive personalizzabili.

Cod. 04739/BL
Dorso: 4

Cod. 04739/GL
Dorso: 4

Cod. 04739/RS
Dorso: 4

Cod. 04739/VR
Dorso: 4

Cod. 04740/BL
Dorso: 6

Cod. 04740/GL
Dorso: 6

Cod. 04740/RS
Dorso: 6

Cod. 04740/VR
Dorso: 6

Cod. 04741/BL
Dorso: 8

Cod. 04741/GL
Dorso: 8

Cod. 04741/RS
Dorso: 8

Cod. 04741/VR
Dorso: 8

Cod. 04742/BL
Dorso: 10

Cod. 04742/GL
Dorso: 10

Cod. 04742/RS
Dorso: 10

Cod. 04742/VR
Dorso: 10

Cod. 04745/BL
Dorso: 12

Cod. 04745/GL
Dorso: 12

Cod. 04745/RS
Dorso: 12

Cod. 04745/VR
Dorso: 12

Cod. 04746/BL
Dorso: 15

Cod. 04746/GL
Dorso: 15

Cod. 04746/RS
Dorso: 15

Cod. 04746/VR
Dorso: 15

 1
U.M.V.

 12
Imballo

CARTELLA PORTAPROGETTO "CRETA"



Con **bottone ed elastico**, 6 colori "creta".
Formato **25 x 35 cm**, in PPL.

Cod. 55390/3
Dorso: 3 cm

Cod. 55390/7
Dorso: 7 cm

Cod. 55390/5
Dorso: 5 cm

Cod. 55390/10
Dorso: 10 cm



CARTELLA PORTAPROGETTO "TIFFANY"

Con **bottone ed elastico**, 6 colori "tiffany".
Formato **25 x 35 cm**, in PPL.

Cod. 55387/3
Dorso: 3 cm

Cod. 55387/7
Dorso: 7 cm

Cod. 55387/5
Dorso: 5 cm

Cod. 55387/10
Dorso: 10 cm



CARTELLA PORTAPROGETTO CON ELASTICO

Con **elastico**, in PP **traslucido**.



Cod. 20148
Formato: 25 x 35 x 2

Cod. 20150
Formato: 25 x 35 x 3,7





CARTELLA PORTAPROGETTO CON ELASTICO

Con **elastico** in PP **fluorescente**, colori assortiti.

Cod. 20149

Formato: 25 x 35 x 2

Cod. 20151

Formato: 25 x 35 x 3,7



 12
U.M.V.

 48
Imballo

 12
U.M.V.

 48
Imballo

CARTELLA CON ELASTICO

Con **elastico**, in PP **fluo**, 6 colori traslucidi assortiti.

Cod. 19683

Formato: 25 x 35

Cod. 09232

Formato: 33 x 43



 24
U.M.V.

 120
Imballo

 12
U.M.V.

 120
Imballo



13

CARTELLA CON DOPPIO ELASTICO

Con **doppio elastico**, in PP **fluo**, 6 colori assortiti.

Cod. 19703

Formato: 23 x 35



 24
U.M.V.

 120
Imballo



CARTELLA

Con elastico, in cartone, colori fluorescenti, formato 25 x 35 cm.



Cod. 04734/AQ

Cod. 04734/GL

Cod. 04734/AR

Cod. 04734/LL

Cod. 04734/AZ

Cod. 04734/RS

Cod. 04734/BL

Cod. 04734/VCH

Cod. 04734/FC

Cod. 04734/VR

Cod. 04734/ASS



CARTELLA

Con elastico, in cartone, colori pastello. Formato 25 x 35 cm.

13

Cod. 55199/ARP

Cod. 55199/CLP

Cod. 55199/GLP

Cod. 55199/LIP

Cod. 55199/ROP

Cod. 55199/VRP

Cod. 55199/ASSP



CARTELLA

Con elastico, in cartone, formato 17 x 24 cm.



Cod. 04735/AR

Cod. 04735/BL

Cod. 04735/GL

Cod. 04735/RS

Cod. 04735/VR





CARTELLA

A soffietto in PP con chiusura ad elastico,
13 tasche interne, 6 colori fluorescenti assortiti.

Cod. 19701

Formto: 11 x 22



CARTELLA

A soffietto in PP con chiusura ad elastico,
13 tasche interne, 6 colori traslucidi assortiti.

Cod. 19681

Formto: 11 x 22



13



CARTELLA

A soffietto, in PP, 24 x 33, chiusura a doppio elastico, **13 tasche interne, colori fluorescenti o pastello**

Cod. 20039/PA

Formto: 24 x 33 cm

Colore: pastello



Cod. 20039/FL

Formto: 24 x 33 cm

Colore: fluo



CARTELLA 3 LEMBI

In carta pannosa **190 g/m²**, con **copertina stampata**.
Confezione da **50 pezzi** per singolo colore.

- Cod. 15369/AZ
- Cod. 15369/AR
- Cod. 15369/RS
- Cod. 15369/GL
- Cod. 15369/GR
- Cod. 15369/VR



CARTELLA 3 LEMBI

In carta pannosa **190 g/m²**, **senza stampa**.
Confezione da **50 pezzi** per singolo colore.

- Cod. 22600/AZ
- Cod. 22600/AR
- Cod. 22600/RS
- Cod. 22600/GL
- Cod. 22600/GR
- Cod. 22600/VR



CARTELLA 3 LEMBI

In carta Bristol **200 g/m²**, **senza stampa, colori forti**.
Confezione da **50 pezzi** per singolo colore.

- Cod. 28087/AZ
- Cod. 28087/RS
- Cod. 28087/GL
- Cod. 28087/VR
- Cod. 28087/AR



CARTELLA SEMPLICE

In carta pannosa **145 g/m²**, **copertina stampata**.
 Confezione da **100 pezzi** per singolo colore.

- Cod. 15370/AZ
- Cod. 15370/GL
- Cod. 15370/RO
- Cod. 15370/RS
- Cod. 15370/GR
- Cod. 15370/AR
- Cod. 15370/VR

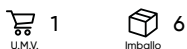

CARTELLA CON FINESTRA "CLEAR VIEW"

In carta **120 g/m²**, formato **22 x 31 cm**.
 Confezione **25 pezzi** per singolo colore.

- Cod. 00551/AZ
- Cod. 00551/GL
- Cod. 00551/GR
- Cod. 00551/RO
- Cod. 00551/VR



13

CARTELLA PRODUZIONE

Formato **25 x 35 cm**,
 in cartoncino bristol **240 g/m²**,
 con copertina stampata.
 Confezione da **50 pezzi**
 per singolo colore.

- Cod. 11609/CL
- Cod. 11609/RO
- Cod. 11609/RS
- Cod. 11609/GL
- Cod. 11609/VR



RACCOGLITORE 4 ANELLI TIFFANY

Formato 25 x 35, colori assortiti.

Cod. 55385/16
Diametro anello: 16 mm

Cod. 55385/30
Diametro anello: 30 mm



20
U.M.V.

40
Imballo



RACCOGLITORE 4 ANELLI CRETA

Formato 25 x 35, colori assortiti.

Cod. 55388/16
Diametro anello: 16 mm

Cod. 55388/30
Diametro anello: 30 mm



20
U.M.V.

40
Imballo



RACCOGLITORE 4 ANELLI

Formato 19 x 22, **in cartone rivestito**.
Confezione da 20 pezzi in 10 colori.

Cod. 19690
Diametro anello: 25

1
U.M.V.

20
Imballo





RACCOGLITORE 4 ANELLI

Formato 28 x 32 cm, in **cartone rivestito opaco**,
5 colori assortiti

Cod. 11185/VR

Cod. 11185/BL

Cod. 11185/GL

Cod. 11185/NR

Cod. 11185/RS

Diametro anello: 30

 20
U.M.V.

 40
Imballo

RACCOGLITORE 4 ANELLI

Formato 28 x 32, in **cartone da 900 g/m²**,
rivestito opaco, colori assortiti.

Cod. 19691/ASS

Cod. 19691/BL

Cod. 19691/GL

Cod. 19691/NR

Cod. 19691/RS

Diametro anello: 30

 20
U.M.V.

 40
Imballo



13

RACCOGLITORE 4 ANELLI

Formato 27 x 32, in **cartone rivestito**.
6 colori assortiti.

Cod. 19692

Diametro anello: 40

Cod. 19693

Diametro anello: 50

 1
U.M.V.

 20
Imballo



RACCOGLITORE 4 ANELLI TRENDY

4 anelli, ø 30, colori **fluorescenti assortiti**.

Cod. 19205/ASS
Diametro anello: 30

U.M.V. 20

Imballo 20



RACCOGLITORE 4 ANELLI

Personalizzabile, 4 anelli "D", in cartone rivestito, **tasca frontale e laterale personalizzabile**.

Cod. 19694/BN
Diametro anello: 30

Cod. 19694/BL
Diametro anello: 30

U.M.V. 1

Imballo 24

Cod. 19695/BN
Diametro anello: 40

Cod. 19695/BL
Diametro anello: 40

U.M.V. 1

Imballo 24

Cod. 19696/BN
Diametro anello: 50

Cod. 19696/BL
Diametro anello: 50

U.M.V. 1

Imballo 12

Cod. 19697/BN
Diametro anello: 65

Cod. 19697/BL
Diametro anello: 65

U.M.V. 1

Imballo 12



RACCOGLITORE 4 ANELLI

4 anelli, formato **25 x 30 cm**, colori **pastello**.

Cod. 22314/30
Diametro anello: 30

Cod. 22314/16
Diametro anello: 16



U.M.V. 12

Imballo 48



RACCOGLITORE 2 ANELLI

In PPL, 2 anelli, 6 colori **fluorescenti**.

Cod. 19686
 Formato: 25,5 x 31 cm
 Diametro anello: 16

Cod. 27211/FL
 Formato: 18,5 x 23 cm
 Diametro anello: 16

U.M.V. 12 Imballo 72

Cod. 19700
 Formato: 25,5 x 31 cm
 Diametro anello: 30

Cod. 27210
 Formato: ASST
 Diametro anello: ASST



U.M.V. 12 Imballo 48

U.M.V. 1 Imballo 1



Espositore da banco in cartone: 18 pezzi ø 16 formato A4, 6 pezzi ø 30 formato A4, 6 pezzi ø 16 formato 18,5 x 23 cm.



RACCOGLITORE 4 ANELLI

A 4 anelli in 6 colori **traslucidi**.

Cod. 19688/TR
 Formato: 25,5 x 31 cm
 Diametro anello: 16

Cod. 19689
 Formato: 25,5 x 31 cm
 Diametro anello: 30

Cod. 27205
 Formato: ASST
 Diametro anello: ASST

Cod. 19689/TR
 Formato: 25,5 x 31 cm
 Diametro anello: 30

Cod. 27211/ASS
 Formato: 18,5 x 23
 Diametro anello: 16, 2 anelli

U.M.V. 1 Imballo 1

Cod. 19688
 Formato: 25,5 x 31 cm
 Diametro anello: 16

U.M.V. 12 Imballo 72

U.M.V. 12 Imballo 48



Espositore da banco in cartone: 18 pezzi ø 16 formato A4, 6 pezzi ø 30 formato A4, 6 pezzi ø 16 formato 18,5 x 23 cm.



RACCOGLITORE "TOUCH" 4 ANELLI

4 anelli, 6 colori assortiti con effetti finitura "touch".

Cod. 09235

Formato: 25,5 x 31 cm
Diametro anello: 16

Cod. 09235/ESP

Formato: 25,5 x 31 cm
Diametro anello: ASST

Cod. 09236

Formato: 25,5 x 31 cm
Diametro anello: 30

1
U.M.V.

1
Imballo

24
U.M.V.

48
Imballo

Espositore da banco in cartone: 15 pezzi ø 16 formato A4, 15 pezzi ø 30 formato A4.



BUSTE FORATURA UNIVERSALE

PP riciclabile, **indeformabili, resistenti**.
Confezione in busta da **50 pezzi**.

Cod. 20162

Formato: 22 x 30
Spessore: 10 µ
Finitura: Liscia

Cod. 01814

Formato: 22 x 30
Spessore: 15 µ
Finitura: Buccia

Cod. 06912

Formato: 22 x 30
Spessore: 15 µ
Finitura: Liscia

Cod. 06916

Formato: 14,8 x 21
Spessore: 15 µ
Finitura: Liscia

Cod. 06913

Formato: 22 x 30
Spessore: 18 µ
Finitura: Liscia

1
U.M.V.

20
Imballo



BUSTE A L

PP riciclabile, **indeformabili, resistenti**, confezione in busta da **50 pezzi**.

Cod. 20033

Spessore: Alto

Modello: L

Finitura: Liscia

 1
U.M.V.

 20
Imballo



INTERCALARI

Formato A4, **foratura universale**, in PPL o carta.



Cod. 19707

Modello: 6 Tasti Colorati

Materiale: Carta

Cod. 19687

Modello: 12 Tasti Colorati

Materiale: Carta

 12
U.M.V.

 30
Imballo

Cod. 10878/02

Modello: 1-31

Materiale: PPL

 12
U.M.V.

 20
Imballo

Cod. 10878/01

Modello: 12 tasti colorati

Materiale: PPL

Cod. 10878/03

Modello: A-Z

Materiale: PPL

Cod. 10878/04

Modello: 6 Tasti Colorati

Materiale: PPL

 12
U.M.V.

 50
Imballo

BUSTA CON BOTTONE

PPL 18 micron, **colori traslucidi**. Confezioni assortite in 6 colori.

Cod. 19705/A4
Formato: A4

Cod. 19705/A5
Formato: A5

Cod. 19705/DL
Formato: 10*22

12 U.M.V. 240 Imballo

Cod. 19705/A6
Formato: A6

12 U.M.V. 420 Imballo

Cod. 19705/A7
Formato: A7

12 U.M.V. 300 Imballo

Cod. 19705/A3
Formato: A3

12 U.M.V. 120 Imballo

Cod. 19705/ESP
Formato: Asst.

1 U.M.V. 4 Imballo

Espositore da banco in cartone:
120 pezzi, 24 per modello.



13

BUSTA CON BOTTONE

PPL 18 micron, formato **A4**, colori singoli **traslucidi**.

Cod. 19705/A4AR

Cod. 19705/A4BL

Cod. 19705/A4GL

Cod. 19705/A4NT

Cod. 19705/A4RS

Cod. 19705/A4VR

12 U.M.V. 240 Imballo

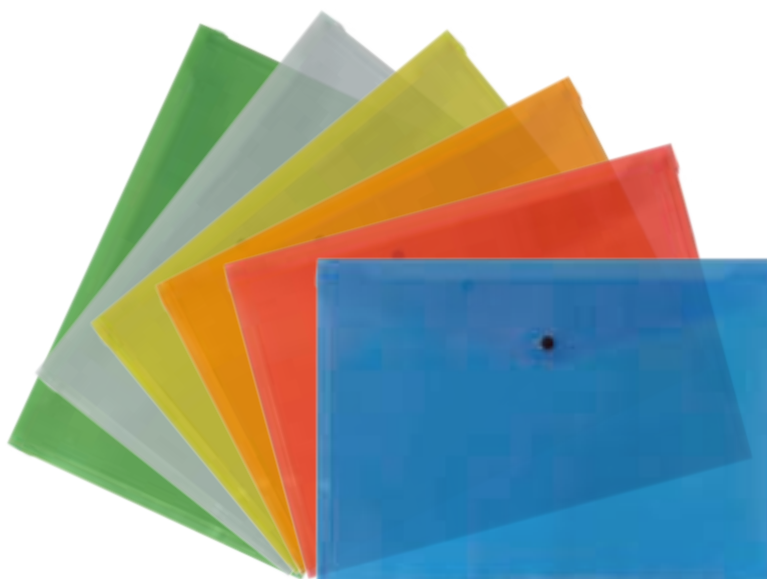

BUSTA CON BOTTONE

PPL 18 micron, **colori opachi**, confezione colori assortiti.

Cod. 09231/A4
Formato: A4

Cod. 09231/A5
Formato: A5

Cod. 09231/DL
Formato: 10*22

12 U.M.V. 240 Imballo

Cod. 09231/A6
Formato: A6

12 U.M.V. 420 Imballo

Espositore da banco in cartone: 120 pezzi, 24 per modello.

Cod. 09231/A7
Formato: A7

12 U.M.V. 300 Imballo

Cod. 09231/ESP
Formato: Asst.

1 U.M.V. 4 Imballo



BUSTA CON BOTTONE

PPL 18 micron, confezione **colori fluorescenti** assortiti.

Cod. 19706/A4
Formato: A4

Cod. 19706/A5
Formato: A5

Cod. 19706/A6
Formato: 10*22

12 U.M.V. 240 Imballo

Cod. 19706/DL
Formato: A6

12 U.M.V. 420 Imballo

Espositore da banco in cartone: 120 pezzi, 24 per modello.

Cod. 19706/A7
Formato: A7

12 U.M.V. 300 Imballo

Cod. 19706/A3
Formato: A3

12 U.M.V. 120 Imballo

Cod. 19706/ESP
Formato: Asst.

1 U.M.V. 4 Imballo



BUSTA CON BOTTONE

PPL, 18 micron, **colori pastello**, confezione 12 pezzi assortita in 6 colori, formati A3, A4 e A5.

Cod. 20048/A3
Formato: A3

Cod. 20048/A4
Formato: A4

Cod. 20048/A5
Formato: A5



 12 U.M.V.  240 Imballo



13

BUSTE CON ZIP

In PPL 18 micron, confezione 6 **colori traslucidi**.

Cod. 07901/A5
Formato: 28*18,5

Cod. 07901/A4
Formato: 33*24

Cod. 07901/A3
Formato: 45*33

Cod. 07901/ESP
Formato: Asst.

 1 U.M.V.  4 Imballo

 12 U.M.V.  48 Imballo

Espositore da banco in cartone: 108 pezzi, 36 per modello.

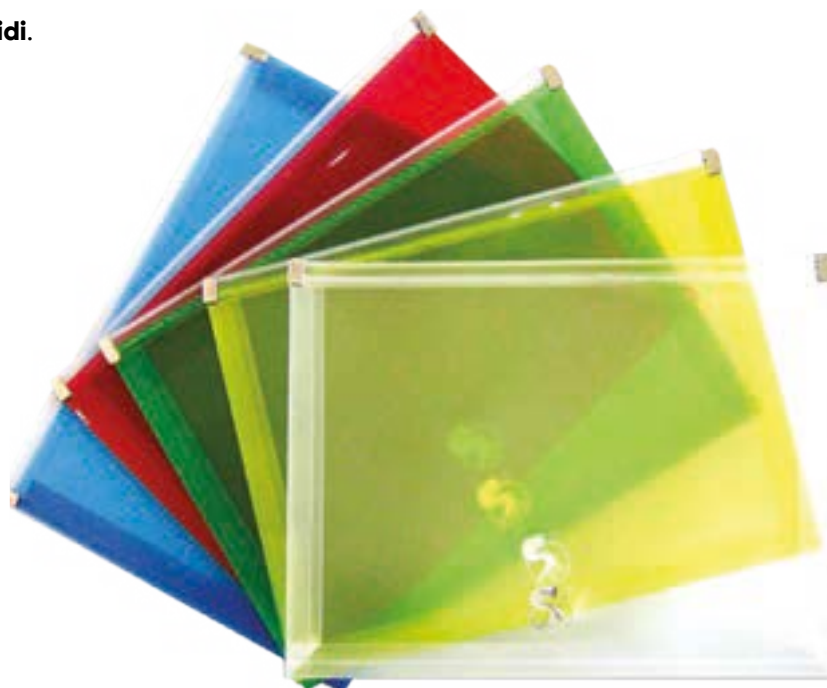



MESH ZIPPER BAGS

Busta **con zip**, disponibile nei formati **A4** e **A5**.

Cod. 21035/A4

Cod. 21035/A5

 1
U.M.V.

 120
Imballo





PORTATESINA







In PP con **copertina trasparente**, clip laterale in metallo, colori assortiti, formato **A4**.

Cod. 19680/ASS	Cod. 19680/GL
Cod. 19680/AR	Cod. 19680/NR
Cod. 19680/BL	Cod. 19680/RS
Cod. 19680/BN	Cod. 19680/VR



PORTALISTINO PERSONALIZZABILE



PPL trasparente, formato **22 x 30 cm**, protezione superiore, **tasca frontale personalizzabile**.

Cod. 19672/10 Buste: 10	Cod. 19672/40 Buste: 40	Cod. 19672/80 Buste: 80
Cod. 19672/20 Buste: 20	Cod. 19672/50 Buste: 50	Cod. 19672/100 Buste: 100
Cod. 19672/30 Buste: 30	Cod. 19672/60 Buste: 60	 6 U.M.V.  48 Imballo
 12 U.M.V.  48 Imballo	 12 U.M.V.  48 Imballo	



PORTALISTINO PERSONALIZZABILE

PPL, **6 colori traslucidi** assortiti, formato **22 x 30 cm**, protezione superiore, **tasca frontale personalizzabile**.

Cod. 20163/10 Buste: 10	Cod. 20163/40 Buste: 40	Cod. 20163/80 Buste: 80
Cod. 20163/20 Buste: 20	Cod. 20163/50 Buste: 50	
Cod. 20163/30 Buste: 30	Cod. 20163/60 Buste: 60	 6 U.M.V.  48 Imballo



PORTALISTINO

PPL, 6 colori fluorescenti assortiti, formato 22 x 30 cm.

Cod. 20153/10
Buste: 10

Cod. 20153/20
Buste: 20

Cod. 20153/30
Buste: 30

Cod. 20153/40
Buste: 40

Cod. 20153/50
Buste: 50

Cod. 20153/60
Buste: 60

Cod. 20163/80
Buste: 80

Cod. 20163/100
Buste: 100



PORTALISTINO

PPL, 4 colori classici.

Cod. 20152/BL
Buste: 10

Cod. 20152/NR
Buste: 10

Cod. 20152/RS
Buste: 10

Cod. 20152/VR
Buste: 10

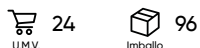

Cod. 20154/BL
Buste: 20

Cod. 20154/NR
Buste: 20

Cod. 20154/RS
Buste: 20

Cod. 20154/VR
Buste: 20

Cod. 20156/BL
Buste: 30

Cod. 20156/NR
Buste: 30

Cod. 20156/RS
Buste: 30

Cod. 20156/VR
Buste: 30



Cod. 20158/BL
Buste: 40

Cod. 20158/NR
Buste: 40

Cod. 20158/RS
Buste: 40

Cod. 20158/VR
Buste: 40

Cod. 20160/BL
Buste: 50

Cod. 20160/NR
Buste: 50

Cod. 20160/RS
Buste: 50

Cod. 20160/VR
Buste: 50

Cod. 23759/BL
Buste: 60

Cod. 23759/NR
Buste: 60

Cod. 23759/RS
Buste: 60

Cod. 23759/VR
Buste: 60



Cod. 23760/BL
Buste: 80

Cod. 23760/NR
Buste: 80

Cod. 23760/RS
Buste: 80

Cod. 23760/VR
Buste: 80



Cod. 23761/BL
Buste: 100

Cod. 23761/NR
Buste: 100

Cod. 23761/RS
Buste: 100

Cod. 23761/VR
Buste: 100



RACCOGLITORE ITALY COMMERCIALE



Portadocumenti, formato **commerciale 31 x 29 x 8 cm**, in cartone pressato, meccanismo di chiusura in metallo. Custodia e raccoglitore colorato.

Cod. 28187/AR

Cod. 28187/BL

Cod. 28187/FC

Cod. 28187/GL

Cod. 28187/RS

Cod. 28187/VR



RACCOGLITORE ITALY MEMO



Portadocumenti, formato **memo 19 x 29 x 8 cm**, in cartone pressato, meccanismo di chiusura in metallo. Custodia e raccoglitore colorato.

Cod. 28186/AR

Cod. 28186/BL

Cod. 28186/FC

Cod. 28186/GL

Cod. 28186/RS

Cod. 28186/VR



13

RACCOGLITORE ITALY



Portadocumenti, formato **34 x 29 x 8 cm**, in cartone pressato, meccanismo di chiusura in metallo. Custodia e raccoglitore colorato.

Cod. 28184/AR

Cod. 28184/BL

Cod. 28184/FC

Cod. 28184/GL

Cod. 28184/RS

Cod. 28184/VR



RACCOGLITORE ITALY DORSO 5



Portadocumenti, formato **34 x 29 x 5, cm** in cartone pressato, meccanismo di chiusura in metallo. Custodia e raccoglitore colorato.

- Cod. 28185/AR**
- Cod. 28185/BL**
- Cod. 28185/FC**
- Cod. 28185/GL**
- Cod. 28185/RS**
- Cod. 28185/VR**

 8
U.M.V.

 8
Imballo

RACCOGLITORE CLASSIC



Formato **34 x 29 x 8 cm**, in cartone pressato, meccanismo di chiusura in metallo, custodia nera e raccoglitore colorato.

- Cod. 04242/GL**
- Cod. 04242/BL**
- Cod. 04242/RS**
- Cod. 04242/VR**

 6
U.M.V.

 6
Imballo

RACCOGLITORE CLASSIC DORSO 5



Formato **34 x 29 x 5 cm**, in cartone pressato, con meccanismo di chiusura in metallo, custodia nera e raccoglitore colorato.

- Cod. 04243/GL**
- Cod. 04243/BL**
- Cod. 04243/RS**
- Cod. 04243/VR**

 8
U.M.V.

 8
Imballo



CARTELLE ARCHIVIO

Cartelle archivio con **legaccio**, in confezioni da **25 pezzi**.

Cod. 05506/5

Dorso: 5

Cod. 05506/15

Dorso: 15

Cod. 05506/8

Dorso: 8

Cod. 05506/18

Dorso: 18

Cod. 05506/10

Dorso: 10

Cod. 05506/20

Dorso: 20

Cod. 05506/12

Dorso: 12

 25
U.M.V.

 150
Imballo



CARTELLA SOSPESA

Cartella sospesa in cartone.

Cod. 19765
Formato: 39 cm
Fondo: V
Per: Cassettiera

Cod. 12982
Formato: 39 cm
Fondo: U
Per: Cassettiera

Cod. 02667
Formato: 33 cm
Fondo: V
Per: Armadio

 50 U.M.V.  50 Imballo

LAVAGNE SPIL, PER PICCOLI
APPUNTI e GRANDI PROGETTI!



LAVAGNE

LAVAGNE MAGNETICHE	234
LAVAGNE IN SUGHERO	236
PENNARELLI PER LAVAGNE	237
SPILLI CARTOGRAFICI	238
CANCELLINI	238



14

LAVAGNA MAGNETICA

Vetro temperato bianco, vassoio porta penne in alluminio, ganci da parete. Disponibile in 2 misure.

Cod. 56139/4560

Formato: 45 x 60

Cod. 56139/6090

Formato: 60 x 90



U.M.V.



Imballo

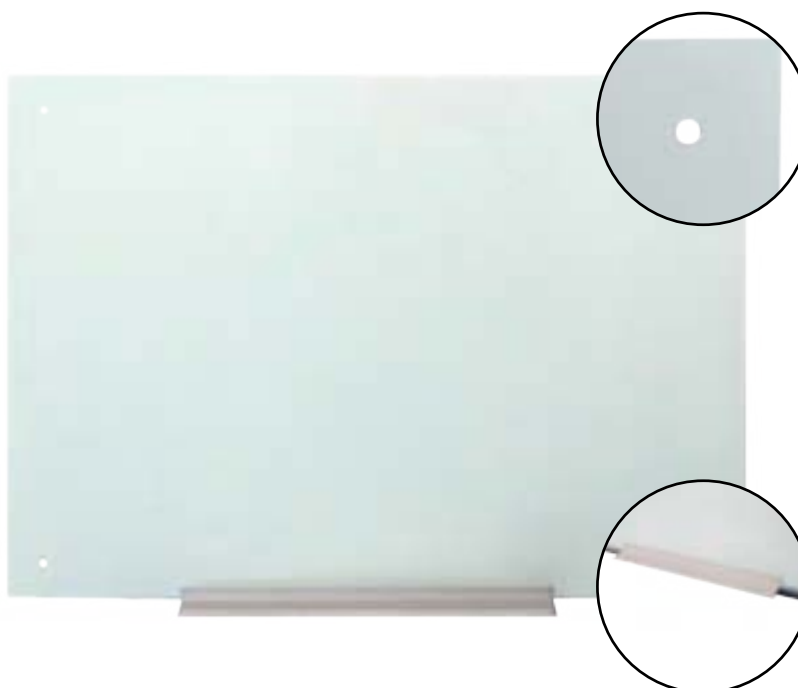

LAVAGNA MAGNETICA

Fondo bianco, cornice in alluminio,
vano porta-oggetti, ganci per fissaggio a muro.

Cod. 15200/3045

Formato: 30 x 45



1

U.M.V.



24

Imballo

Cod. 15200/90120

Formato: 90 x 120



1

U.M.V.



2

Imballo

Cod. 15200/4560

Formato: 45 x 60



1

U.M.V.



12

Imballo

Cod. 27218

Formato: 90 x 150



1

U.M.V.



2

Imballo

Cod. 15200/6090

Formato: 60 x 90



1

U.M.V.



6

Imballo

Cod. 27219

Formato: 120 x 180



1

U.M.V.



1

Imballo



LAVAGNA FLIPCHART

70 x 100 cm, base con ruote
orientabili, con ganci per fogli mobili.

Cod. 15203



1

U.M.V.



1

Imballo

LAVAGNA FLIPCHART

70 x 100 cm, base a tre piedi, con ganci per fogli mobili.

Cod. 27220



14

LAVAGNA IN SUGHERO

Cornice in legno e set di spilli cartografici colorati, disponibile in 3 misure.



Cod. 15201/3045

Formato: 30 x 45

Cod. 15201/4560

Formato: 45 x 60

Cod. 15201/6090

Formato: 60 x 90



LAVAGNA DOPPIA

Metá in sughero e metá bianca, scrivibile a secco, completa di set spilli cartografici e marker.



Cod. 15202/3045

Formato: 30 x 45

Cod. 15202/4560

Formato: 45 x 60



1

U.M.V.



12

Imballo

marki

whiteboard S312

Marcatore **per lavagna bianca**, lavagna a secco, vetro e superfici non porose. Inchiostro ad asciugatura rapida, **facile da cancellare**. Si rimuove senza lasciare tracce.

Espositore da 36 pezzi: 18 nero, 6 blu, 6 rosso, 6 verde.

Confezione colore singolo da 12 pezzi.



MARCATORE
CANCELLABILE

Cod. 22564/NR

Cod. 22564/BL

Cod. 22564/RS

Cod. 22564/VR



1

U.M.V.



72

Imballo

Cod. 22564/ESP



1

U.M.V.



12

Imballo



Espositore marki
whiteboard S312



SPILLI CARTOGRAFICI

Confezione da **100 pezzi**, 5 colori,
in astuccio appendibile.

Cod. 55035

 24
U.M.V.

 24
Imballo



14

CANCELLINI MAGNETICI

Per lavagne bianche.



Cod. 15204/01

Modello: Mouse

 24
U.M.V.

 24
Imballo

Cod. 15204/05

Modello: Cuore

 12
U.M.V.

 12
Imballo

Cod. 15204/02

Modello: Rettangolo

 24
U.M.V.

 24
Imballo

Cod. 15204/06

Modello: Auto

 12
U.M.V.

 12
Imballo

Cod. 15204/03

Modello: Ergonomico

 12
U.M.V.

 12
Imballo

Cod. 15204/07

Modello: Stella

 12
U.M.V.

 12
Imballo

Cod. 15204/04

Modello: Mano

 12
U.M.V.

 12
Imballo

Cod. 15204/08

Modello: Matita

 12
U.M.V.

 12
Imballo



ORGANIZZA e PROTEGGI con Spil!

PORTA Documenti

PORTA CARDS	242
ETICHETTE PER BAGAGLI.....	250
PORTA DOCUMENTI.....	251



PORTACARDS

2 tasche trasparenti, espositore 50 pezzi.

Cod. 01710

Dimensione: 9,5 x 6,4



U.M.V.



Imballo

15



PORTACARDS

6 tasche trasparenti, espositore 50 pezzi.

Cod. 01333

Dimensione: 8 x 11,7



U.M.V.



Imballo



PORTACARDS MORBIDO

1 tasca, espositore 70 pezzi.



Cod. 11268
Dimensione: 5,7 x 8,9



PORTACARDS MORBIDO

2 tasche, espositore 70 pezzi.

Cod. 15049
Dimensione: 5,7 x 9



PORTACARDS RIGIDO

1 tasca, espositore 50 pezzi.

Cod. 07978
Dimensione: 5,7 x 9





PORTACARDS

1 tasca, fantasia, espositore 72 pezzi assortiti.

Cod. 15046

Dimensione: 6 x 9



1

U.M.V.



12

Imballo



PORTACARDS + PORTACARTA D'IDENTITÀ

Espositore 12 pezzi assortiti.

Cod. 15041

Dimensione: 8,5 x 12,4

15



1

U.M.V.



12

Imballo





PORTACARDS

16 tasche, espositore 12 pezzi assortiti.

Cod. 05676

Dimensione: 7 x 10



PORTACARDS ANTITRUFFA

2 tasche, protezione RFID / NFC,
espositore 24 pezzi assortiti.

Cod. 15043

Dimensione: 6,8 x 9,5



15

PORTACARDS ELITE

1 tasca, morbido, espositore 75 pezzi assortiti.

Cod. 15048

Dimensione: 10 x 7,5



PORTACARDS

2 tasche, morbido, espositore 30 pezzi assortiti.



Cod. 01351
Dimensione: 6,8 x 9,5



PORTACARDS

4 tasche, morbido, espositore 35 pezzi assortiti.

Cod. 01330
Dimensione: 6 x 9



PORTACARDS

6 tasche, morbido, espositore 30 pezzi assortiti.

Cod. 01353
Dimensione: 7 x 10





PORTACARDS

6 tasche, morbido, espositore 12 pezzi assortiti.

Cod. 01342
Dimensione: 7 x 10



15



PORTACARDS SMILE

8 posti, espositore 18 pezzi, fantasie assortite.

Cod. 15047
Dimensione: 7 x 10



PORTACARDS FANTASIE

8 tasche, espositore 18 pezzi fantasie assortite.



Cod. 15045

Dimensione: 7 x 10



PORTACARDS

8 tasche, espositore 12 pezzi assortiti.

Cod. 07980

Dimensione: 7 x 10

15



PORTACARDS

8 tasche a libro, espositore 16 pezzi assortiti.



Cod. 14639

Dimensione: 7 x 10





PORTACARDS

8 tasche, espositore 12 pezzi assortiti.

Cod. 01354
Dimensione: 7 x 10



15

PORTACARDS

10 tasche, espositore 12 pezzi assortiti.

Cod. 15044
Dimensione: 6 x 10





PORTA ETICHETTA PER BAGAGLIO

Bagaglio in confezione da 50 pezzi assortiti.

Cod. 01356

Dimensione: 5,7 x 8,9



U.M.V.



Imballo



15

PORTACARDS

7 tasche, custodia in alluminio,
espositore 6 pezzi assortiti.

Cod. 01344

Dimensione: 10 x 7,5



U.M.V.



Imballo





PORTA CARTA DI IDENTITÀ

Trasparente, **apertura a busta**, confezione 100 pezzi.

Cod. 09582

Dimensione: 16 x 11,7



U.M.V.



Imballo

PORTA CARTA DI IDENTITÀ

Trasparente, **apertura a libro**, confezione 50 pezzi.

Cod. 55323

Dimensione: 16 x 11,7



U.M.V.



Imballo



15



PORTACARDS RIGIDO

Prodotto scatolato singolarmente. **6 tasche.**

Cod. 55930

Dimensione: 10 x 7,5



U.M.V.



Imballo

Mai piú senza!

PRATICI E COMODI SCEGLI LE "SPILCARDS" PER
CUSTODIRE I TUOI DOCUMENTI!



15

Cod. 54731/BIANCO
 1  1
UMV. Imballo



CARTE SPECIALI SPIL PER
MOMENTI INDIMENTICABILI



CARTE SPECIALI

CARTONCINI CHARTAE	256
CARTONCINI GOFFRATI	256
CARTA PERGAMENATA.....	257
CARTONCINI MOMENTI.....	258

CHARTAE WHITE

Cartoncino bianco per stampa e rilegature.

Cod.	Formato	Fogli	Grammatura
Cod. 57050/200	A4	200	200
Cod. 57050/250	A4	200	250
Cod. 57051/200	A3	100	200
Cod. 57051/250	A3	100	250

 1
U.M.V.

 10
Imballo



CHARTAE COLOR

Cartoncino **200 g/m²**, dimensioni **21 x 29,7 cm**, in risma da **100 fogli**, colori forti o pastello.

Cod. 11403/FT
Colore: Forte

 1
U.M.V.

 10
Imballo

Cod. 11403/TN
Colore: Tenue

 1
U.M.V.

 10
Imballo

CARTONCINO GOFFRATO

230g/m², dimensione 21 x 29,7 cm,
in risme da **100 fogli**. Ideale per stampare e rilegare.

Cod. 22973/01	Cod. 22973/11
Cod. 22973/02	Cod. 22973/12
Cod. 22973/03	Cod. 22973/14
Cod. 22973/04	Cod. 22973/15
Cod. 22973/05	Cod. 22973/16
Cod. 22973/07	Cod. 22973/29
Cod. 22973/08	Cod. 22973/30
Cod. 22973/09	

 1
U.M.V.

 10
Imballo





MOMENTI

Cartoncino perlato **230 g/m²**, formato A4.
Confezione da **100 fogli**.

Cod. 56134/BN

Cod. 56134/RS

Cod. 56134/RO

Cod. 56134/AV

Cod. 56134/CE

Cod. 56134/BL

Cod. 56134/AR

Cod. 56134/ARG

Cod. 56134/OR

Cod. 56134/PE



1

U.M.V.



10

Imballo

MOMENTI

Cartoncino perlato **120 g/m²**, formato A4.
Confezione da **100 fogli**.

Cod. 22570/BN

Cod. 22570/AG

Cod. 22570/AV

Cod. 22570/BL

Cod. 22570/OR

Cod. 22570/PE

Cod. 22570/RS



1

U.M.V.



10

Imballo



16



MOMENTI

Carta pergamena pregiata **160 g/m²**,
disponibile in due colori: bianco ed avorio e
due formati: A4 e A3. Confezione da **100 fogli**
in **A4** e da **50 fogli** in **A3**.

Cod. 54642/AV

Colore: Avorio

Formato: A4

Cod. 54643/AV

Colore: Avorio

Formato: A3

Cod. 54642/BN

Colore: Bianco

Formato: A4

Cod. 54643/BN

Colore: Bianco

Formato: A3



1



5



MOMENTI

Cartoncino canvas **230 g/m²**, formato A4.
Confezione da **100 fogli**.

Cod. 56133/BL

Cod. 56133/BN

Cod. 56133/NR

Cod. 56133/RS



MOMENTI

Cartoncino canvas **120 g/m²**, formato A4.
Confezione da **100 fogli**.

Cod. 22569/BN

Cod. 22569/BL

Cod. 22569/RS

Cod. 22569/NR



16



MOMENTI

Cartoncino glossy **120 g/m²**, formato A4.
Confezione da **100 fogli**.

Cod. 22581/BN

Cod. 22581/AV



MOMENTI

Cartoncino glossy **230 g/m²**, formato A4.
Confezione da **100 fogli**.

Cod. 22582/BN

Cod. 22582/AV





MOMENTI

Cartoncino soft **120 g/m²**, formato A4.
Confezione da **100 fogli**.

Cod. 22587/BN

Cod. 22587/MR

Cod. 22587/RS

Cod. 22587/VR

Cod. 22587/NR

1
U.M.V.

10
Imballo



MOMENTI

Cartoncino soft **230 g/m²**, formato A4.
Confezione da **100 fogli**.

Cod. 22588/BN

Cod. 22588/MR

Cod. 22588/RS

Cod. 22588/VR

Cod. 22588/NR

1
U.M.V.

10
Imballo



BLOCCO NUMERATO

Blocco numerato **1-100** con **fogli staccabili**.
Disponibile in confezione da **50 pezzi** o in display da banco.

Cod. 03919

50
U.M.V.

250
Imballo



PLANNING SETTIMANALE

Planning settimanale da tavolo,
formato **30 x 42 cm**, **52 fogli da 80 g/m²**.

Cod. 54464

1
U.M.V.

50
Imballo

Spil: PER UNA PRESENTAZIONE IMPECCABILE!



RILEGATURA

COPERTINE IN PVC	262
POUCHES PER PLASTIFICAZIONE	262
NASTRO INVISIBILE	263
NASTRO TELATO	263
RILEGATRICE	264
DORSINI IN PLASTICA	265
SPIRALI IN PLASTICA	266

COPERTINE IN PVC

Per rilegatura, risme da **100 fogli**.

Cod.	Formato	Spessore
Cod. 22970	A4	150 µ
Cod. 22971	A4	200 µ
Cod. 04457	A3	200 µ
Cod. 22972/BL	A4	200 µ
Cod. 22972/FM	A4	200 µ
Cod. 22972/GL	A4	200 µ
Cod. 22972/MR	A4	200 µ
Cod. 22972/RS	A4	200 µ
Cod. 22972/VR	A4	200 µ



1

U.M.V.



10

Imballo



POUCHES

Per plastificazione.

Confezione da **100 pezzi**.

Cod.	Formato	Spessore
Cod. 15185	303 x 426	80 µ
Cod. 15186	303 x 426	125 µ
Cod. 15187	216 x 303	80 µ
Cod. 15188	216 x 303	125 µ
Cod. 15189	154 x 216	125 µ
Cod. 15190	111 x 154	125 µ
Cod. 15194	75 x 105	125 µ
Cod. 15191	65 x 95	125 µ
Cod. 15192	60 x 90	125 µ
Cod. 15193	54 x 86	125 µ



1

U.M.V.



5

Imballo



1

U.M.V.



10

Imballo

NASTRO INVISIBILE

Adesivo, formato **19 x 33 cm.**
Confezione singola blisterata.

Cod. 23319

Formato: 19 x 33

10
U.M.V.

480
Imballo



NASTRO TELATO

250 micron, formato **38 x 25 mt**,
ideale per la rilegatura.
Ogni rotolo é blisterato singolarmente.

Cod. 23318/BL

Cod. 23318/BN

Cod. 23318/GL

Cod. 23318/NR

Cod. 23318/RS

Cod. 23318/VR

Formato: 38 x 25

1
U.M.V.

36
Imballo

NASTRO TELATO

250 micron, formato **50 x 25 mt**,
ideale per la rilegatura.
Ogni rotolo é blisterato singolarmente.

Cod. 54713/BL

Cod. 54713/BN

Cod. 54713/RS

Formato: 50 x 25

1
U.M.V.

36
Imballo



CARTONCINO GOFFRATO

230g/m², dimensione 21 x 29,7 cm,
in risme da **100 fogli**. Ideale per stampare e rilegare.

Cod. 22973/01	Cod. 22973/11
Cod. 22973/02	Cod. 22973/12
Cod. 22973/03	Cod. 22973/14
Cod. 22973/04	Cod. 22973/15
Cod. 22973/05	Cod. 22973/16
Cod. 22973/07	Cod. 22973/29
Cod. 22973/08	Cod. 22973/30
Cod. 22973/09	



1

U.M.V.



10

Imballo



RILEGATRICE MANUALE

Per spirali in plastica, braccio in metallo, capacità di rilegatura **fino a 500 fogli**, capacità di perforazione **fino a 25 fogli**, per spirali **da ø 6 mm fino a ø 51 mm**.

Cod. 56175



1

U.M.V.



1

Imballo



DORSINI IN PLASTICA

Per rilegare, **dorso 4 mm**, capacità **fogli 2-25**.
Confezione 100 pezzi.

Cod. 22989/BL

Cod. 22989/BN

Cod. 22989/GL

Cod. 22989/NR

Cod. 22989/RS

Cod. 22989/TR

Cod. 22989/VR



1

U.M.V.



10

Imballo



DORSINI IN PLASTICA

Per rilegare, **dorso 6 mm**, capacità **fogli 26-35**.
Confezione 100 pezzi.

Cod. 22990/BL

Cod. 22990/BN

Cod. 22990/GL

Cod. 22990/NR

Cod. 22990/RS

Cod. 22990/TR

Cod. 22990/VR



1

U.M.V.



10

Imballo



17

DORSINI IN PLASTICA

Per rilegare, **dorso 8mm**, capacità **fogli 36-40**.
Confezione 100 pezzi.

Cod. 22991/BL

Cod. 22991/BN

Cod. 22991/GL

Cod. 22991/NR

Cod. 22991/RS

Cod. 22991/TR

Cod. 22991/VR



1

U.M.V.



10

Imballo



DORSINI IN PLASTICA

Per rilegare **dorso 12 mm**, capacità **fogli 41-80**.
Confezione 100 pezzi.

Cod. 22992/BL

Cod. 22992/BN

Cod. 22992/GL

Cod. 22992/NR

Cod. 22992/RS

Cod. 22992/TR

Cod. 22992/VR



1

U.M.V.



10

Imballo



DORSINI IN PLASTICA

Per rilegare **dorso 15 mm**, capacità **fogli 81-105**.
Confezione 100 pezzi.

Cod. 22993/BL

Cod. 22993/BN

Cod. 22993/GL

Cod. 22993/NR

Cod. 22993/RS

Cod. 22993/TR

Cod. 22993/VR



1

U.M.V.



10

Imballo



17

SPIRALI IN PLASTICA

Per rilegare **ø 6 mm**, capacità **fogli 2-20**.
Confezione 100 pezzi.

Cod. 22974/BL

Cod. 22974/BN

Cod. 22974/GL

Cod. 22974/NR

Cod. 22974/RS

Cod. 22974/TR

Cod. 22974/VR



1

U.M.V.



10

Imballo



SPIRALI IN PLASTICA

Per rilegare \varnothing 8 mm, capacità fogli 21-40.
Confezione 100 pezzi.

- Cod. 22975/BL
- Cod. 22975/BN
- Cod. 22975/GL
- Cod. 22975/NR
- Cod. 22975/RS
- Cod. 22975/TR
- Cod. 22975/VR

 1  20
U.M.V. Imballo

SPIRALI IN PLASTICA

Per rilegare \varnothing 10 mm, capacità fogli 41-55.
Confezione 100 pezzi.

- Cod. 22976/BL
- Cod. 22976/BN
- Cod. 22976/GL
- Cod. 22976/NR
- Cod. 22976/RS
- Cod. 22976/TR
- Cod. 22976/VR

 1  20
U.M.V. Imballo

SPIRALI IN PLASTICA:

Per rilegare \varnothing 12 mm, capacità fogli 56-80.
Confezione 100 pezzi.

- Cod. 22977/BL
- Cod. 22977/BN
- Cod. 22977/GL
- Cod. 22977/NR
- Cod. 22977/RS
- Cod. 22977/TR
- Cod. 22977/VR

 1  10
U.M.V. Imballo



SPIRALI IN PLASTICA

Per rilegare \varnothing 14 mm, capacità fogli 81-100.
Confezione 100 pezzi.

Cod. 22978/BL

Cod. 22978/BN

Cod. 22978/GL

Cod. 22978/NR

Cod. 22978/RS

Cod. 22978/TR

Cod. 22978/VR



1

U.M.V.



10

Imballo

SPIRALI IN PLASTICA

Per rilegare \varnothing 16 mm, capacità fogli 101-120.
Confezione 100 pezzi.

Cod. 22979/BL

Cod. 22979/BN

Cod. 22979/GL

Cod. 22979/NR

Cod. 22979/RS

Cod. 22979/TR

Cod. 22979/VR



1

U.M.V.



10

Imballo

SPIRALI IN PLASTICA

Per rilegare \varnothing 18 mm, capacità fogli 121-130.
Confezione 100 pezzi.

Cod. 22980/BL

Cod. 22980/BN

Cod. 22980/GL

Cod. 22980/NR

Cod. 22980/RS

Cod. 22980/TR

Cod. 22980/VR



1

U.M.V.



10

Imballo



SPIRALI IN PLASTICA

Per rilegare \varnothing 19 mm, capacità fogli da 131-140.
Confezione 100 pezzi.

- Cod. 29920/BL
- Cod. 29920/BN
- Cod. 29920/GL
- Cod. 29920/NR
- Cod. 29920/RS
- Cod. 29920/TR
- Cod. 29920/VR

 1 U.M.V.  10 Imballo

SPIRALI IN PLASTICA

Per rilegare \varnothing 20 mm, capacità fogli 141-150.
Confezione 100 pezzi.

- Cod. 22981/BL
- Cod. 22981/BN
- Cod. 22981/GL
- Cod. 22981/NR
- Cod. 22981/RS
- Cod. 22981/TR
- Cod. 22981/VR

 1 U.M.V.  10 Imballo

SPIRALI IN PLASTICA

Per rilegare \varnothing 22 mm, capacità fogli 151-180.
Confezione 50 pezzi.

- Cod. 22982/BL
- Cod. 22982/BN
- Cod. 22982/GL
- Cod. 22982/NR
- Cod. 22982/RS
- Cod. 22982/TR
- Cod. 22982/VR

 1 U.M.V.  10 Imballo



SPIRALI IN PLASTICA

Per rilegare \varnothing 25 mm, capacità fogli 181-200.
Confezione 50 pezzi.

Cod. 29983/BL

Cod. 29983/BN

Cod. 29983/GL

Cod. 29983/NR

Cod. 29983/RS

Cod. 29983/TR

Cod. 29983/VR



1

U.M.V.



10

Imballo

SPIRALI IN PLASTICA

Per rilegare \varnothing 28mm, capacità fogli 201-240.
Confezione 50 pezzi.

Cod. 22984/BL

Cod. 22984/BN

Cod. 22984/GL

Cod. 22984/NR

Cod. 22984/RS

Cod. 22984/TR

Cod. 22984/VR



1

U.M.V.



10

Imballo

SPIRALI IN PLASTICA

Per rilegare \varnothing 32mm, capacità fogli 241-280.
Confezione 50 pezzi.

Cod. 22985/BL

Cod. 22985/BN

Cod. 22985/GL

Cod. 22985/NR

Cod. 22985/RS

Cod. 22985/TR

Cod. 22985/VR



1

U.M.V.



10

Imballo



SPIRALI IN PLASTICA

Per rilegare \varnothing 38 mm, capacità fogli 281-340.
Confezione 50 pezzi.

- Cod. 22986/BL
- Cod. 22986/BN
- Cod. 22986/GL
- Cod. 22986/NR
- Cod. 22986/RS
- Cod. 22986/TR
- Cod. 22986/VR



SPIRALI IN PLASTICA

Per rilegare \varnothing 45 mm, capacità fogli 341-410.
Confezione 50 pezzi.

- Cod. 22987/BL
- Cod. 22987/BN
- Cod. 22987/GL
- Cod. 22987/NR
- Cod. 22987/RS
- Cod. 22987/TR
- Cod. 22987/VR



SPIRALI IN PLASTICA

Per rilegare \varnothing 51 mm, capacità fogli 411-500.
Confezione 50 pezzi.

- Cod. 22988/BL
- Cod. 22988/BN
- Cod. 22988/GL
- Cod. 22988/NR
- Cod. 22988/RS
- Cod. 22988/TR
- Cod. 22988/VR



STAMPA, SCRIVI e CREA con Spil!



CARTA e ROTOLI

CARTA PER FOTOCOPIE	274
ROTOI PER CASSA	275
ROTOI PER POS	275
ROTOI PER PLOTTER	276
ROTOI PER XEROX	276



replika¹

top quality paper

Carta per fotocopie **80 g/m²** in risme da **500 fogli**.

Cod. 03486

Formato: A4

5
U.M.V.

240
Imballo

Cod. 07349

Formato: A5

10
U.M.V.

50
Imballo



18

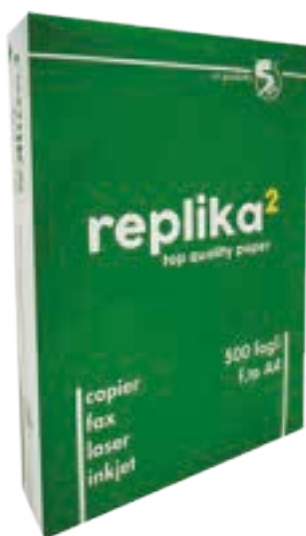

replika²

top quality paper

Carta per fotocopie **75 g/m²**,
in risme da **500 fogli**.

Cod. 09230/A4

5
U.M.V.

240
Imballo

Rotoli SPIL®

Rotoli per registratori di cassa, pos e scommesse.
Carta bianca e **metratura garantita. Gr. 48.**
Blister da 10 pezzi.



Cod.	Dimensione	Descrizione
Cod. 06281	57mm x 15mt x 12mm	Termico non omologato
Cod. 09462	57mm x 15mt x 12mm	Termico omologato
Cod. 04199	57mm x 20mt x 12mm	Termico non omologato
Cod. 16144	57mm x 20mt x 12mm	Termico omologato

 1
U.M.V.
  10
Imballo

Cod.	Dimensione	Descrizione
Cod. 04946	57mm x 30mt x 12mm	Termico omologato
Cod. 02709	57mm x 35mt x 12mm	Termico omologato

 1
U.M.V.
  5
Imballo

Cod.	Dimensione	Descrizione
Cod. 06874	57mm x 40mt x 12mm	Termico omologato
Cod. 07804	57mm x 50mt x 12mm	Termico omologato
Cod. 16131	57mm x 60mt x 12mm	Termico omologato
Cod. 16340	57mm x 80mt x 12mm	Termico omologato
Cod. 16134	80mm x 50mt x 12mm	Termico omologato
Cod. 13862	80mm x 60mt x 12mm	Termico omologato
Cod. 16135	80mm x 80mt x 12mm	Termico omologato
Cod. 16159	80mm x 80mt x 12mm	Termico 80g
Cod. 08848	80mm x 80mt x 12mm	Termico 105g
Cod. 08846	80mm x 80mt x 25mm	Termico

 1
U.M.V.
  5
Imballo

ROTOLO PLOTTER

In carta naturale **90 g/m²** con punto di bianco elevato.
Ideale per stampe di grandi formati.

Cod. 15616/A0+

Dimensioni: 1067mm x 50mt

Cod. 15616/A0

Dimensioni: 914mm x 50mt

Cod. 15616/A1+

Dimensioni: 625mm x 50mt

Cod. 15616/A1

Dimensioni: 610mm x 50mt

Cod. 15616/A2

Dimensioni: 420mm x 50mt



1

U.M.V.



10

Imballo



ROTOLO XERO

In carta naturale **80 g/m²** con punto di bianco elevato.
Ideale per stampe di grandi formati.

Cod. 00912/A0

Dimensioni: 914mm x 150mt

Cod. 00912/A1

Dimensioni: 620mm x 150mt

Cod. 00912/A2

Dimensioni: 420mm x 150mt



1

U.M.V.



10

Imballo



2

U.M.V.



10

Imballo

ROTOLO PLOTTER BLUE BACK

In carta naturale **120 g/m²** con punto di bianco elevato. Ideale per stampe di grandi formati.

Cod. 36674/A0+

Dimensioni: 1067mm x 50mt

Cod. 36674/A0

Dimensioni: 914mm x 50mt

Cod. 36674/A1

Dimensioni: 610mm x 50mt

Cod. 36674/A2

Dimensioni: 420mm x 50mt



ANNUNCI IMPORTANTI e INVITI ESCLUSIVI!

TANTI AUGURI
- Spil

OPALINE e BUSTE PER SPEDIZIONE

OPALINE	280
BUSTE IMBOTTITE	285
BUSTE SPEDIZIONE	286



OPALINA BIANCA

Confezione da **100 buste e 100 biglietti.**

Cod. 08080/01
Formato: 9*14

Cod. 08080/02
Formato: 7*11



1

U.M.V.



5

Imballo



BIGLIETTO BIANCO

Confezione da **100 biglietti.**

Cod. 08080/08
Formato: 7*11

Cod. 08080/09
Formato: 9*14



1

U.M.V.



5

Imballo



BUSTA BIANCA

Confezione da **100 buste.**

Cod. 08080/07
Formato: 7*11

Cod. 08080/06
Formato: 9*14



1

U.M.V.



5

Imballo





OPALINA ROSSA

Confezione da **100 buste** e **100 biglietti**.

Cod. 08080/05
Formato: 7*11

Cod. 08080/04
Formato: 9*14



U.M.V.



Imballo

OPALINA BIANCA TELATA

Confezione da **100 buste** e **100 biglietti**.

Cod. 08080/22
Formato: 9*14

Cod. 08080/21
Formato: 7*11



U.M.V.



Imballo



OPALINA AVORIO

Confezione da **100 buste** e **100 biglietti**.

Cod. 08080/24
Formato: 7*11

Cod. 08080/23
Formato: 9*14



U.M.V.



Imballo





OPALINA ROSA

Confezione da **100 buste** e **100 biglietti**.

Cod. 08080/25
Formato: 9*14



OPALINA AZZURRA

Confezione da **100 buste** e **100 biglietti**.

Cod. 08080/26
Formato: 9*14



OPALINA VERDE

Confezione da **100 buste** e **100 biglietti**.

Cod. 08080/27
Formato: 9*14

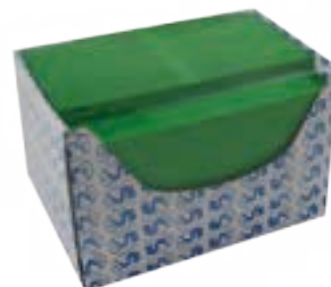



OPALINA COLORI FORTI

Buste e biglietti assortiti in **5 colori forti**.

100 buste e 100
biglietti

Cod. 08080/16
Formato: 5,8*6,8 cm

250 buste e 250
biglietti

Cod. 08080/10
Formato: 7*11 cm

Cod. 08080/11
Formato: 9*14 cm



U.M.V.



Imballo

OPALINA COLORI TENUI

Buste e biglietti assortiti in **5 colori tenui**.

100 buste e 100
biglietti

Cod. 08080/12
Formato: 7*11

Cod. 08080/13
Formato: 9*14



U.M.V.



Imballo



OPALINA MARMOREA

Buste e biglietti assortiti in **5 colori tenui ad effetto marmorizzato**.

100 buste e 100
biglietti

Cod. 08080/19
Formato: 7*11

Cod. 08080/20
Formato: 9*14

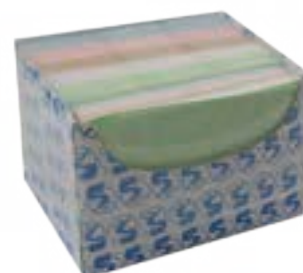

U.M.V.



Imballo



OPALINA METALLIZZATA

Buste e biglietti assortiti in **3 colori metallizzati forti.**

150 buste e 150 biglietti

Cod. 08080/15
Formato: 7*11

Cod. 08080/14
Formato: 9*14



OPALINA METALLIZZATA

Buste e biglietti assortiti in **4 colori metallizzati tenui.**

150 buste e 150 biglietti

Cod. 08080/17
Formato: 7*11

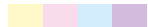

OPALINA LUTTO

100 buste e 100 biglietti.

Cod. 08080/03
Formato: 9*14



BUSTE IMBOTTITE

Carta bianca con bolle d'aria, resistenti all'acqua e agli urti.
Confezione da 10 pezzi.

Cod.	Formato esterno	Formato utile
Cod. 09095/A	120 x 175	100 x 165
Cod. 09095/B	140 x 225	120 x 215

1 U.M.V. 20 Imballo

Cod.	Formato esterno	Formato utile
Cod. 09095/C	170 x 225	150 x 215
Cod. 09095/D	170 x 275	180 x 265
Cod. 09095/CD	200 x 175	180 x 165
Cod. 09095/E	200 x 275	180 x 265
Cod. 09095/FG	250 x 350	230 x 340
Cod. 09095/H	290 x 370	270 x 360

1 U.M.V. 10 Imballo

Cod.	Formato esterno	Formato utile
Cod. 09095/J	320 x 455	300 x 445
Cod. 09095/K	370 x 480	350 x 470

1 U.M.V. 5 Imballo





BUSTE PER SPEDIZIONI

Formato 12 x 18, carta **80 g/m²**.

Cod. 15704
Colore: Bianco

Cod. 15706
Colore: Giallo

Cod. 15706
Colore: Giallo

1 U.M.V. 10 Imballo 50 Pezzi

1 U.M.V. 10 Imballo 50 Pezzi

BUSTE PER SPEDIZIONI

Formato 18 x 24, in carta **80 g/m²**, confezione da 25 pezzi.

Cod. 15707

1 U.M.V. 20 Imballo 25 Pezzi



BUSTE A SACCO PER SPEDIZIONI

Formato 16 x 23, carta bianca **80 g/m²**, autoadesive.
Confezione da 25 pezzi.

Cod. 15903

1 U.M.V. 20 Imballo 25 Pezzi





BUSTE A SACCO PER SPEDIZIONI

Formato 22,9 x 32,4, carta bianca **80 g/m²**, autoadesive. Confezione da 25 pezzi.

Cod. 15946

1 20 25
U.M.V. Imballo Pezzi

BUSTE A SACCO PER SPEDIZIONI

Formato 25 x 35,3, carta bianca **80 g/m²**, autoadesive. Confezione da 25 pezzi.

Cod. 15948

1 20 25
U.M.V. Imballo Pezzi



BUSTE A SACCO PER SPEDIZIONI

Formato 30 x 40, carta bianca **100 g/m²**, autoadesive. Confezione da 25 pezzi.

Cod. 15952

1 20 25
U.M.V. Imballo Pezzi



BUSTE A SACCO PER SPEDIZIONI

Formato 19 x 26, carta bianca **80 g/m²**, autoadesive.
Confezione da 25 pezzi.

Cod. 15945

1 U.M.V. 20 Imballo 25 Pezzi



BUSTE PER SPEDIZIONI

Formato 11 x 23, carta bianca, autoadesive.
Confezione da 25 pezzi.



19

Cod.	Modello	Carta	Pezzi per confezione
Cod. 15894	Senza finestra	90	25
Cod. 15895	Con finestra	90	25

1 U.M.V. 20 Imballo 25 Pezzi

Cod.	Modello	Carta	Pezzi per confezione
Cod. 11745	Senza finestra Con adesivo	80	500
Cod. 11746	Con finestra Con adesivo	80	500
Cod. 11747	Senza finestra Con adesivo	90	500
Cod. 11748	Con finestra Con adesivo	90	500

1 U.M.V. 10 Imballo 500 Pezzi



INCORNICIA i TUOI RICORDI PIÙ PREZIOSI



Cornici

CORNICI A GIORNO	292
CORNICI PIATTINA	292
CORNICI ARTE POVERA	293
CORNICI BURN	293

CORNICE SNAP

Fronte in plexiglass e chiusura a snap.

Cod. 26163/10*15	Cod. 26163/35*50
Cod. 26163/13*18	Cod. 26163/40*50
Cod. 26163/15*20	Cod. 26163/40*60
Cod. 26163/18*24	Cod. 26163/50*60
Cod. 26163/20*25	Cod. 26163/50*70
Cod. 26163/20*30	
Cod. 26163/21*29	
Cod. 26163/24*30	Cod. 26163/60*80
Cod. 26163/25*35	Cod. 26163/70*100
Cod. 26163/30*40	
Cod. 26163/29,7*42	
Cod. 26163/30*45	

U.M.V. 4 Imballo 8

U.M.V. 2 Imballo 4

U.M.V. 6 Imballo 12



CORNICE PIATTINA

Bordo in legno colorato, vetro 2 mm.

Cod. 26160/10*15	Cod. 26160/21*29
Cod. 26160/13*18	Cod. 26160/24*30
Cod. 26160/15*20	Cod. 26160/25*35



U.M.V. 6 Imballo 8

U.M.V. 4 Imballo 8

Cod. 26160/ 50*70



U.M.V. 2 Imballo 6



CORNICE ARTE POVERA

Bordo in **legno lavorato da 3 mm, vetro 2 mm.**

Cod. 26162/ 10*15

Cod. 26162/ 13*18

Cod. 26162/ 15*20

 6
U.M.V.

 8
Imballo

Cod. 26162/ 35*50

Cod. 26162/ 40*50

Cod. 26162/ 50*70

 2
U.M.V.

 6
Imballo

Cod. 26162/ 21*29

Cod. 26162/ 24*30

Cod. 26162/ 30*40

 4
U.M.V.

 8
Imballo



CORNICE BRUN

Bordo in **legno lavorato con finiture dorate, vetro 2 mm.**

Cod. 26161/ 10*15

Cod. 26161/ 13*18

Cod. 26161/ 15*20

Cod. 26161/ 18*24

 6
U.M.V.

 12
Imballo

Cod. 26161/ 21*29

Cod. 26161/ 24*30

Cod. 26161/ 25*35

Cod. 26161/ 30*40

 4
U.M.V.

 8
Imballo

Cod. 26161/ 35*50

Cod. 26161/ 40*50

Cod. 26161/ 50*70

 2
U.M.V.

 6
Imballo

Confeziona le Tue idee con Spil!



Confezionamento

BUSTE DA REGALO	296
BUSTE PORTA BOTTIGLIE	303
SCATOLE DA REGALO	305
CARTA DA IMBALLO	307



BUSTA CON CORDONCINO

Misura **18 x 8 x 24**.
Confezione da **25 pezzi**.

Cod. 13006/AN

Cod. 13006/GL

Cod. 13006/ANS

Cod. 13006/MA

Cod. 13006/AR

Cod. 13006/MR

Cod. 13006/AV

Cod. 13006/NR

Cod. 13006/AZ

Cod. 13006/RS

Cod. 13006/BLN

Cod. 13006/VM

Cod. 13006/BN

Cod. 13006/VR

Cod. 13006/BO

 25
U.M.V.

 450
Imballo

21



Inchiostri

Stampate con inchiostri ad acqua e vernice di protezione. Stampa a fondo pieno con maniglie in carta in tinta.



Kraft Bianco

Le shopper in kraft bianco sono prodotte con carta riciclabile. La carta ha un'elevata resistenza ed è un prodotto certificato FSC®



Certificazione FSC

Shopper in carta certificata FSC.



BUSTA CON CORDONCINO

Misura **22 x 10 x 29**.
Confezione da **25 pezzi**.

Cod. 12975/AN	Cod. 12975/GL
Cod. 12975/ANS	Cod. 12975/MA
Cod. 12975/AR	Cod. 12975/MR
Cod. 12975/ARG	Cod. 12975/ORO
Cod. 12975/AV	Cod. 12975/RO
Cod. 12975/AZ	Cod. 12975/NR
Cod. 12975/BLN	Cod. 12975/RS
Cod. 12975/BN	Cod. 12975/VM
Cod. 12975/BO	Cod. 12975/VR

 25
U.M.V.

 300
Imballo



Inchiostri

Stampate con inchiostri ad acqua e vernice di protezione. Stampa a fondo pieno con maniglie in carta in tinta.



Kraft Bianco

Le shopper in kraft bianco sono prodotte con carta riciclabile. La carta ha un'elevata resistenza ed è un prodotto certificato FSC®



Certificazione FSC

Shopper in carta certificata FSC.



BUSTA CON CORDONCINO

Misura **26 x 11 x 35**.
Confezione da **25 pezzi**.

Cod. 17584/AN	Cod. 17584/GL
Cod. 17584/ANS	Cod. 17584/MA
Cod. 17584/AR	Cod. 17584/MR
Cod. 17584/ARG	Cod. 17584/ORO
Cod. 17584/AV	Cod. 17584/RO
Cod. 17584/AZ	Cod. 17584/NR
Cod. 17584/BLN	Cod. 17584/RS
Cod. 17584/BN	Cod. 17584/VM
Cod. 17584/BO	Cod. 17584/VR

 25
U.M.V.

 300
Imballo

21



Inchiostri

Stampate con inchiostri ad acqua e vernice di protezione. Stampa a fondo pieno con maniglie in carta in tinta.



Kraft Bianco

Le shopper in kraft bianco sono prodotte con carta riciclabile. La carta ha un'elevata resistenza ed è un prodotto certificato FSC®



Certificazione FSC

Shopper in carta certificata FSC.



BUSTA CON CORDONCINO

Misura **36 x 12 x 41**.
Confezione da **25 pezzi**.

Cod. 14167/AN	Cod. 14167/GL
Cod. 14167/ANS	Cod. 14167/MA
Cod. 14167/AR	Cod. 14167/MR
Cod. 14167/ARG	Cod. 14167/ORO
Cod. 14167/AV	Cod. 14167/RO
Cod. 14167/AZ	Cod. 14167/NR
Cod. 14167/BLN	Cod. 14167/RS
Cod. 14167/BN	Cod. 14167/VM
Cod. 14167/BO	Cod. 14167/VR



25

U.M.V.



150

Imballo



Inchiostri

Stampate con inchiostri ad acqua e vernice di protezione. Stampa a fondo pieno con maniglie in carta in tinta.



Kraft Bianco

Le shopper in kraft bianco sono prodotte con carta riciclabile. La carta ha un'elevata resistenza ed è un prodotto certificato FSC®



FSC

Certificazione FSC

Shopper in carta certificata FSC.



BUSTA CON CORDONCINO

Misura **45 x 15 x 50**.
Confezione da **25 pezzi**.

Cod. 14426/AN

Cod. 14426/GL

Cod. 14426/ANS

Cod. 14426/MA

Cod. 14426/AR

Cod. 14426/MR

Cod. 14426/AV

Cod. 14426/NR

Cod. 14426/AZ

Cod. 14426/RS

Cod. 14426/BLN

Cod. 14426/VM

Cod. 14426/BN

Cod. 14426/VR

Cod. 14426/BO

 25
U.M.V.

 150
Imballo

21



Inchiostri

Stampate con inchiostri ad acqua e vernice di protezione. Stampa a fondo pieno con maniglie in carta in tinta.



Kraft Bianco

Le shopper in kraft bianco sono prodotte con carta riciclabile. La carta ha un'elevata resistenza ed è un prodotto certificato FSC®



Certificazione FSC

Shopper in carta certificata FSC.

BUSTA CORDONCINO

Mix **assortito** in confezione da **25 pezzi**.

Cod. 56652/ASS

Formato: 220 x 100 x 290



25

U.M.V.



300

Imballo

Cod. 56653/ASS

Formato: 260 x 110 x 350



25

U.M.V.



200

Imballo

Cod. 56654/ASS

Formato: 360 x 120 x 420



25

U.M.V.



150

Imballo



Inchiostri

Stampate con inchiostri ad acqua e vernice di protezione. Stampa a fondo pieno con maniglie in carta in tinta.



Kraft Bianco

Le shopper in kraft bianco sono prodotte con carta riciclabile. La carta ha un'elevata resistenza ed è un prodotto certificato FSC®



Certificazione FSC

Shopper in carta certificata FSC.

BUSTA CON CORDONCINO

Misura **25 x 15 x 24**,
confezione da **15 pezzi**.

Cod. 11149/AN

Cod. 11149/AV

Cod. 11149/BN

Cod. 11149/MR

Cod. 11149/RS

 15
U.M.V.

 195
Imballo



BUSTA CON CORDONCINO

Misura **35 x 22 x 32**,
confezione da **15 pezzi**.

Cod. 11150/AN

Cod. 11150/AV

Cod. 11150/BN

Cod. 11150/MR

Cod. 11150/RS

 15
U.M.V.

 120
Imballo



BUSTA PIATTINA

In confezione da **25 pezzi**.

Cod. 14759/AN

Formato: 18 x 8 x 25

Cod. 14759/BN

Formato: 18 x 8 x 25

Cod. 14760/AN

Formato: 22 x 10 x 29

Cod. 14760/BN

Formato: 22 x 10 x 29

Cod. 14761/AN

Formato: 26 x 11 x 35

Cod. 14761/BN

Formato: 26 x 11 x 35

Cod. 14762/AN

Formato: 32 x 16 x 44

Cod. 14762/BN

Formato: 32 x 16 x 44

Cod. 14763/AN

Formato: 36 x 12 x 41

Cod. 14763/BN

Formato: 36 x 12 x 41

Cod. 14766/AN

Formato: 45 x 15 x 50

Cod. 14766/BN

Formato: 45 x 15 x 50

 25
U.M.V.

 200
Imballo



Inchiostri

Stampate con inchiostri ad acqua e vernice di protezione. Stampa a fondo pieno con maniglie in carta in tinta.



Kraft Bianco

Le shopper in kraft bianco sono prodotte con carta riciclabile. La carta ha un'elevata resistenza ed è un prodotto certificato FSC®



Certificazione FSC

Shopper in carta certificata FSC.

BUSTA PORTABOTTIGLIE CON CORDONCINO

Misura **14 x 9 x 38**,
confezione da **20 pezzi**.

Cod. 23001/AN

Cod. 23001/BLN

Cod. 23001/BO

Cod. 23001/NR

Cod. 23001/VR

 20
U.M.V.

 100
Imballo



BUSTA PORTABOTTIGLIE CON CORDONCINO IN TINTA

Misura **14 x 9 x 38**,
confezione da **20 pezzi**.

Cod. 11086/RS

 20
U.M.V.

 100
Imballo



Inchiostri

Stampate con inchiostri ad acqua e vernice di protezione. Stampa a fondo pieno con maniglie in carta in tinta.



Kraft Bianco

Le shopper in kraft bianco sono prodotte con carta riciclabile. La carta ha un'elevata resistenza ed è un prodotto certificato FSC®



Certificazione FSC

Shopper in carta certificata FSC.

BUSTA PORTABOTTIGLIE CON CORDINO

N.B. Foto puramente indicativa.

Cod. 14849/NR
Modello: Barolo
Formato: 12 x 9 x 39

Cod. 14850/NR
Modello: Barolo
Formato: 18 x 10 x 41

Cod. 14851/AN
Modello: Point
Formato: 12 x 9 x 39

Cod. 14852/AN
Modello: Point
Formato: 18 x 10 x 41

Cod. 14875/AV
Modello: Colors
Formato: 12 x 9 x 39

Cod. 14875/BLN
Modello: Colors
Formato: 12 x 9 x 39

Cod. 14875/BO
Modello: Colors
Formato: 12 x 9 x 39

Cod. 14875/RS
Modello: Colors
Formato: 12 x 9 x 39

Cod. 14876/ARG
Modello: Cabernet
Formato: 12 x 9 x 39

Cod. 14876/BLN
Modello: Cabernet
Formato: 12 x 9 x 39

Cod. 14876/BO
Modello: Cabernet
Formato: 12 x 9 x 39

Cod. 14876/ORO
Modello: Cabernet
Formato: 12 x 9 x 39

Cod. 14877/ARG
Modello: Raboso
Formato: 12 x 9 x 39

Cod. 14877/BN
Modello: Raboso
Formato: 12 x 9 x 39

Cod. 14877/BO
Modello: Raboso
Formato: 12 x 9 x 39

Cod. 14877/NR
Modello: Raboso
Formato: 12 x 9 x 39

Cod. 14877/ORO
Modello: Raboso
Formato: 12 x 9 x 39

 10 U.M.V.  100 Imballo

Cod. 14849/BN
Modello: Barolo
Formato: 14 x 9 x 20

 25 U.M.V.  150 Imballo



Inchiostri

Stampate con inchiostri ad acqua e vernice di protezione. Stampa a fondo pieno con maniglie in carta in tinta.



Kraft Bianco

Le shopper in kraft bianco sono prodotte con carta riciclabile. La carta ha un'elevata resistenza ed è un prodotto certificato FSC®



Certificazione FSC

Shopper in carta certificata FSC.



CARTONE PORTABOTTIGLIE RED

N.B. Foto puramente indicativa.

Cod. 54632/01
Formato: 100 x 100 x 350
Posti: 1

10
U.M.V.

50
Imballo

Cod. 54632/02
Formato: 180 x 90 x 370
Posti: 2

Cod. 54632/03
Formato: 260 x 90 x 370
Posti: 3

10
U.M.V.

30
Imballo

SCATOLA COFANETTO RED CON CORDINI

N.B. Foto puramente indicativa.

Cod. 54632/06
Formato: 245 x 245 x 150

Cod. 54632/07
Formato: 300 x 300 x 240

5
U.M.V.

20
Imballo



VASSOIO RED

N.B. Foto puramente indicativa.

Cod. 54632/08
Formato: 350 x 260 x 100

Cod. 54632/09
Formato: 400 x 300 x 120

5
U.M.V.

20
Imballo



CARTONE PORTABOTTIGLIE "KRAFT"



N.B. Foto puramente indicativa.

Cod. 54634/01

Formato: 100 x 100 x 370
Posti: 1

🛒 10
U.M.V.

📦 50
Imballo

Cod. 54634/02

Formato: 180 x 90 x 370
Posti: 2

Cod. 54634/03

Formato: 260 x 90 x 370
Posti: 3

🛒 10
U.M.V.

📦 30
Imballo

SCATOLA COFANETTO "KRAFT" CON CORDINI

N.B. Foto puramente indicativa.

Cod. 54634/05

Formato: 280 x 200 x 350

Cod. 54634/06

Formato: 245 x 245 x 150

Cod. 54634/07

Formato: 300 x 300 x 240

Cod. 54634/10

Formato: 200 x 200 x 350

Cod. 54634/11

Formato: 290 x 355 x 195

🛒 5
U.M.V.

📦 20
Imballo



VASSOIO "KRAFT"

N.B. Foto puramente indicativa.

Cod. 54634/08

Formato: 350 x 260 x 100

Cod. 54634/09

Formato: 400 x 300 x 120

🛒 5
U.M.V.

📦 20
Imballo



CARTA DA IMBALLO

Formato **100 x 140 cm**,
50 fogli piegati, colore bianco/avana.

Cod. 14750/AV

Cod. 14750/BN

Modello: Avana 80 g **Modello: Bianca 80 g**

 50
U.M.V.

 250
Imballo

 50
U.M.V.

 250
Imballo

Cod. 14750/31

Modello: Bianca 31 g

 100
U.M.V.

 500
Imballo



CARTA DA IMBALLO

Formato **100 x 140 cm**, balleto **5 kg**,
 colore bianco/avana.

Cod. 57621

Cod. 57621/BN

Modello: Avana 80 g

Modello: Bianca 80 g

 5 kg
U.M.V.

 5 kg
Imballo

 5 kg
U.M.V.

 5 kg
Imballo



ANIMA LA TUA FESTA con SPIL!

Palloncini

PALLONCINI AD ELIO.....	310
PALLONCINI AD ARIA.....	310
PALLONCINI MODELLABILI.....	312

PALLONCINI AD ELIO CON STAMPA

Confezione da **25 pezzi**.

Cod. 05979/01

Comunione

Cod. 05979/02

Matrimonio

Cod. 05979/03

1 compleanno rosa

Cod. 05979/04

1 compleanno celeste

Cod. 05979/05

18 anni

Cod. 05979/06

Battesimo rosa

Cod. 05979/07

Battesimo celeste

Cod. 05979/08

25 Anniversario

Cod. 05979/09

50 Anniversario

Cod. 05979/11

Buon Compleanno



5

U.M.V.



10

Imballo



PALLONCINI AD ARIA CON STAMPA

Confezione da **25 pezzi**.

Cod. 05977/01

Comunione

Cod. 05977/02

Matrimonio

Cod. 05977/03

1 compleanno rosa

Cod. 05977/04

1 compleanno celeste

Cod. 05977/05

18 anni

Cod. 05977/06

Battesimo rosa

Cod. 05977/07

Battesimo celeste

Cod. 05977/08

25 Anniversario

Cod. 05977/09

50 Anniversario

Cod. 05977/11

Buon compleanno



5

U.M.V.



10

Imballo



PALLONCINI "10" COLORATI

Buste da **100 pezzi** per singolo colore.

Cod. 05971/ASS	Cod. 05971/NR
Cod. 05971/AR	Cod. 05971/ORO
Cod. 05971/ARG	Cod. 05971/RS
Cod. 05971/AV	Cod. 05971/VCH
Cod. 05971/BN	Cod. 05971/RO
Cod. 05971/BL	Cod. 05971/VR
Cod. 05971/GL	Cod. 05971/CL
Cod. 05971/LI	



U.M.V.



Imballo 10





PALLONCINO MACARON

Confezione da **100 pezzi** assortiti, colori pastello.

Cod. 05971/MA



PALLONCINI ASSORTITI

Confezione da **25 pezzi**.

Cod. 56638



PALLONCINI MODELLABILI

Colori assortiti.

Cod. 05971/PRE

Cod. 05977/10





PALLONCINI "BOMBE D'ACQUA"

Confezione da **200 pezzi**, colori assortiti.

Cod. 05977/12



U.M.V.



Imballo

POMPETTA PER GONFIAGGIO PALLONCINI

Cod. 05980



U.M.V.



Imballo



COLTIVA i TUOI HOBBY con SPIL!



Hobbistica

FORME IN PLASTICA.....	316
FORME IN POLISTIROLO.....	321
COLLE GLITTER.....	328
GLITTER.....	331

FORME IN PLASTICA

Ideali per uso didattico.

Tutti i prodotti sono **conformi** al regolamento **EU 10/2011** riguardante il contatto tra prodotti in plastica e prodotti alimentari.



Cod.	Modello	Misura
Cod. 02087/110	Goccia	H. 110

10 U.M.V. 100 Imballo

Cod.	Modello	Misura
Cod. 02087/140	Goccia	H. 140

Cod.	Modello	Misura
Cod. 02087/180	Goccia	H. 180

Cod.	Modello	Misura
Cod. 02076	Goccia c/nido	H. 180

5 U.M.V. 50 Imballo

Cod.	Modello	Misura
Cod. 02017	Campana	H. 90

10 U.M.V. 100 Imballo

Cod.	Modello	Misura
Cod. 02014/55	Campana c/batacchio	H. 55

Cod.	Modello	Misura
Cod. 02014/70	Campana c/batacchio	H. 70

5 U.M.V. 50 Imballo

Cod.	Modello	Misura
Cod. 02057/100	Spindle	H. 100

10 U.M.V. 100 Imballo

Cod.	Modello	Misura
Cod. 02057/120	Spindle	H. 120

5 U.M.V. 50 Imballo

Cod.	Modello	Misura
Cod. 02036/100	Skittle	H. 100

10 U.M.V. 100 Imballo

Cod.	Modello	Misura
Cod. 02059	Stella	H. 100

Cod.	Modello	Misura
Cod. 02090	Stalattite	H. 140

Cod.	Modello	Misura
Cod. 02094	Rombo	H. 85

Cod.	Modello	Misura
Cod. 02044	Mela	H. 100

Cod.	Modello	Misura
Cod. 02045	Casa	H. 100

Cod.	Modello	Misura
Cod. 02047	Sfera	H. 80

Cod.	Modello	Misura
Cod. 02048	Spindle	H. 100

Cod.	Modello	Misura
Cod. 02046/80	Cuore	H. 80

Cod.	Modello	Misura
Cod. 02046/100	Cuore	H. 100

5 U.M.V. 50 Imballo



Cod.	Modello	Misura
Cod. 02037/30	Sfera	ø 30
Cod. 02037/40	Sfera	ø 40
Cod. 02037/50	Sfera	ø 50
Cod. 02037/60	Sfera	ø 60
Cod. 02037/70	Sfera	ø 70
Cod. 02037/80	Sfera	ø 80
Cod. 02037/100	Sfera	ø 100

 10 U.M.V.  100 Imballo

Cod.	Modello	Misura
Cod. 02037/120	Sfera	ø 120
Cod. 02037/140	Sfera	ø 140
Cod. 02037/160	Sfera	ø 160
Cod. 02037/180	Sfera	ø 180
Cod. 02037/200	Sfera	ø 200

 5 U.M.V.  50 Imballo

Cod.	Modello	Misura
Cod. 02005/60	Uovo	H. 60
Cod. 02005/80	Uovo	H. 80
Cod. 02005/100	Uovo	H. 100

 10 U.M.V.  100 Imballo

Cod.	Modello	Misura
Cod. 02005/120	Uovo	H. 120
Cod. 02005/140	Uovo	H. 140
Cod. 02005/160	Uovo	H. 160
Cod. 02008	Uovo c/base	H. 110
Cod. 02011	Uovo c/nido	H. 160

 5 U.M.V.  50 Imballo

Cod.	Modello	Misura
Cod. 02025/60	Cuore	H. 60
Cod. 02025/80	Cuore	H. 80
Cod. 02025/100	Cuore	H. 100

 10 U.M.V.  100 Imballo

Cod.	Modello	Misura
Cod. 02025/140	Cuore	H. 140

 5 U.M.V.  50 Imballo

Cod.	Modello	Misura
Cod. 02040/70	Medaglione	H. 70
Cod. 02040/90	Medaglione	H. 90
Cod. 02040/110	Medaglione	H. 110

 10 U.M.V.  100 Imballo



Cod.	Modello	Misura
Cod. 01980/100	Albero	H. 100
Cod. 01980/130	Albero	H. 130
Cod. 01981	Orsetto	H. 100
Cod. 02012	Papera	H. 100
Cod. 02018	Coniglio	H. 90
Cod. 02019	Coniglio Salvadanaio	H. 130
Cod. 02035	Gatto	H. 100

 4
U.M.V.

 40
Imballo

Cod.	Modello	Misura
Cod. 02038	Pulcino	H. 90
Cod. 02056/130	Farfalla	H. 130
Cod. 02056/200	Farfalla	H. 200
Cod. 02071	Maiolino Salvadanaio	H. 90
Cod. 02013	Aereo	H. 120
Cod. 02089	Camion	H. 120
Cod. 02039	Treno Salvadanaio	H. 110
Cod. 02109	Maggiolone	H. 130

 4
U.M.V.

 40
Imballo



Cod.	Modello	Misura
Cod. 01986/60	Disco piatto	ø 60
Cod. 01986/85	Disco piatto	ø 85
Cod. 01986/99	Disco piatto	ø 99
Cod. 01986/110	Disco piatto	ø 110
Cod. 01988/80	Uovo piatto	H. 80
Cod. 01988/94	Uovo piatto	H. 94
Cod. 01988/120	Uovo piatto	H. 120
Cod. 01988/140	Uovo piatto	H. 140
Cod. 02001	Ovale piatto	H. 100
Cod. 01991	Cuore piatto	H. 100
Cod. 01990	Campana piatta	H. 95
Cod. 01987	Stella piatta	H. 80
Cod. 01997	Albero piatto	H. 100
Cod. 01989	Finestra piatta	H. 90

10 U.M.V. 100 Imballo

Cod.	Modello	Misura
Cod. 02051/80	Separatore sfera	ø 80
Cod. 02051/100	Separatore sfera	ø 100
Cod. 02051/120	Separatore sfera	ø 120
Cod. 02051/140	Separatore sfera	ø 140
Cod. 02051/160	Separatore sfera	ø 160
Cod. 02053	Separatore uovo	H. 160
Cod. 02052	Separatore cuore	H. 100
Cod. 02054	Separatore goccia	H. 180
Cod. 02050	Cornice cuore	H. 180
Cod. 02049	Cornice stella	H. 220

4 U.M.V. 40 Imballo

Cod.	Modello	Misura
Cod. 01979	Mela	H. 100

10 U.M.V. 100 Imballo



Cod.	Modello	Misura
Cod. 02020	Casetta	H. 100
Cod. 02041/100	Babbo Natale	H. 100
Cod. 02041/130	Babbo Natale	H. 130
Cod. 02042	Schiaccianoci	H. 130
Cod. 02055	Pupazzo di neve	H. 100
Cod. 02058	Stivale	H. 100

 4 U.M.V.
  40 Imballo

Cod.	Modello	Misura
Cod. 01982/50	Scatola ottagonale	85 x 85 x 50
Cod. 01983	Scatola quadrata	75 x 75 x 50
Cod. 01984/50	Scatola cuore	100 x 100 x 50
Cod. 01985/60	Scatola cuore bombata	100 x 100 x 60
Cod. 02002	Scatola ovale	110 x 70 x 50
Cod. 02003/43	Scatola tonda	40 x 30
Cod. 02003/85	Scatola tonda	85 x 50

 3 U.M.V.
  30 Imballo

Cod.	Modello	Misura
Cod. 15699/080	Decostar	H. 80

 2 U.M.V.
  10 Imballo

Cod.	Modello	Misura
Cod. 15699/140	Decostar	H. 140

 1 U.M.V.
  5 Imballo

FORME IN POLISTIROLO

Per uso hobbistico e didattico.



Cod.	Modello	Misura	U.M.V.	Imballo
Cod. 29848/4	Sfera	ø 40	90	450
Cod. 29848/5	Sfera	ø 50	80	400
Cod. 29848/6	Sfera	ø 60	70	350
Cod. 29848/7	Sfera	ø 70	50	250
Cod. 29848/8	Sfera	ø 80	45	225
Cod. 29848/9	Sfera	ø 90	40	200
Cod. 29848/10	Sfera	ø 100	30	150
Cod. 29848/11	Sfera	ø 110	25	125
Cod. 29848/12	Sfera	ø 120	20	100
Cod. 29848/14	Sfera Apribile	ø 140	10	50
Cod. 29848/15	Sfera Apribile	ø 150	9	45
Cod. 29848/16	Sfera Apribile	ø 160	8	40
Cod. 29848/18	Sfera Apribile	ø 180	6	30
Cod. 29848/20	Sfera Apribile	ø 200	4	20
Cod. 29848/25	Sfera Apribile	ø 250	3	15
Cod. 29848/30	Sfera Apribile	ø 300	2	10
Cod. 29848/50	Sfera Apribile	ø 500	1	5

Cod.	Modello	Misura	U.M.V.	Imballo
Cod. 29849/5	Palle a spicchi	H. 50	40	200
Cod. 29849/6	Palle a spicchi	H. 60	35	175
Cod. 29849/7	Palle a spicchi	H. 70	30	150
Cod. 29849/8	Palle a spicchi	H. 80	25	125
Cod. 29849/9	Palle a spicchi	H. 90	20	100
Cod. 29849/10	Palle a spicchi	H. 100	18	90
Cod. 29849/11	Palle a spicchi	H. 110	15	75
Cod. 29849/12	Palle a spicchi	H. 120	12	60

Cod.	Modello	Misura	U.M.V.	Imballo
Cod. 29850/01	Albero di Natale	H. 310	4	20



Cod.	Modello	Misura	U.M.V.	Imballo
Cod. 29850/02	Angelo	12 x 9	18	90
Cod. 29850/03	Arcangelo	H. 22	8	40
Cod. 29850/07	Cherubini	10 x 20	10	50

Cod.	Modello	Misura	U.M.V.	Imballo
Cod. 29850/04	Babbo Natale	H. 21	5	25

Cod.	Modello	Misura	U.M.V.	Imballo
Cod. 29850/05	Befana	H. 21	5	25

Cod.	Modello	Misura	U.M.V.	Imballo
Cod. 29850/06	Candela	23 x 11	5	25

Cod.	Modello	Misura	U.M.V.	Imballo
Cod. 29850/08	Chiesetta	19 x 14	7	35

Cod.	Modello	Misura	U.M.V.	Imballo
Cod. 29850/09	Faro su roccia	30 x 17	4	20

Cod.	Modello	Misura	U.M.V.	Imballo
Cod. 29850/10	Fiocco di neve	17 x 9	7	35

Cod.	Modello	Misura	U.M.V.	Imballo
Cod. 29851/01	Palla forata	ø 8	45	225

Cod.	Modello	Misura	U.M.V.	Imballo
Cod. 29851/02	Birillo	H. 15	25	125

Cod.	Modello	Misura	U.M.V.	Imballo
Cod. 29851/03	Bombetta	15 x 6	30	150

Cod.	Modello	Misura	U.M.V.	Imballo
Cod. 29852/4	Cilindro	20 x 4	20	100

Cod.	Modello	Misura	U.M.V.	Imballo
Cod. 29852/7	Cilindro	20 x 7	12	60

Cod.	Modello	Misura	U.M.V.	Imballo
Cod. 29852/9	Cilindro	20 x 9	10	50

Cod.	Modello	Misura	U.M.V.	Imballo
Cod. 29858/8	Medaglia	ø 8	50	250

Cod.	Modello	Misura	U.M.V.	Imballo
Cod. 29858/10	Medaglia	ø 10	35	175



Cod.	Modello	Misura	U.M.V.	Imballo
Cod. 29853/4	Cono	H. 60 ø 40	20	100
Cod. 29853/7	Cono	H. 120 ø 70	12	60
Cod. 29853/9	Cono	H. 200 ø 90	10	50
Cod. 29853/10	Cono	H. 250 ø 100	6	120
Cod. 29853/11	Cono	H. 300 ø 110	4	20
Cod. 29853/14	Cono	H. 370 ø 140	3	15

Cod.	Modello	Misura	U.M.V.	Imballo
Cod. 29859/15	Pigna piena	H. 150	20	100
Cod. 29859/20	Pigna piena	H. 200	15	75
Cod. 29880/20	Pigna piatta	H. 200	25	125

Cod.	Modello	Misura	U.M.V.	Imballo
Cod. 29854/10	Corona piatta	ø 100	40	200
Cod. 29854/12	Corona piatta	ø 120	35	175
Cod. 29854/15	Corona piatta	ø 150	25	125
Cod. 29854/22	Corona piatta	ø 220	20	100
Cod. 29854/25	Corona piatta	ø 250	15	75
Cod. 29854/30	Corona piatta	ø 300	12	60
Cod. 29855/10	Corona piena	ø 100	40	200
Cod. 29855/12	Corona piena	ø 120	35	175
Cod. 29855/15	Corona piena	ø 150	25	125
Cod. 29855/22	Corona piena	ø 220	18	90
Cod. 29855/25	Corona piena	ø 250	12	60
Cod. 29855/30	Corona piena	ø 300	8	40

Cod.	Modello	Misura	U.M.V.	Imballo
Cod. 29860/9	Piramide	90 x 90	17	85
Cod. 29860/12	Piramide	120 x 120	11	55

Cod.	Modello	Misura	U.M.V.	Imballo
Cod. 29863/13	Stella	H. 135	30	150
Cod. 29863/15	Stella	H. 150	30	150



Cod.	Modello	Misura	U.M.V.	Imballo
Cod. 29857/15	Luna	H. 150	30	150
Cod. 29857/20	Luna	H. 200	20	100
Cod. 29857/25	Luna	H. 250	12	60

Cod.	Modello	Misura	U.M.V.	Imballo
Cod. 29861/01	Quadro opache	360 x 270	3	15
Cod. 29861/02	Quadro Cristo	360 x 270	3	15
Cod. 29861/03	Quadro Madonna	360 x 270	3	15
Cod. 29861/04	Quadro Padre Pio	360 x 270	3	15

Cod.	Modello	Misura	U.M.V.	Imballo
Cod. 29856/01	Disco	H. 50 ø 150	6	30
Cod. 29856/02	Disco	H. 50 ø 200	4	20

Cod.	Modello	Misura	U.M.V.	Imballo
Cod. 29856/03	Muffin con gocce	H. 80	20	100

Cod.	Modello	Misura	U.M.V.	Imballo
Cod. 29862/01	Sfera C/fori cerchio	ø 150	8	40
Cod. 29862/02	Sfera C/fori cestino	ø 150	8	40
Cod. 29862/03	Sfera C/fori per luci	ø 150	8	40
Cod. 29862/04	Sfera C/fori triangolo	ø 150	8	40

Cod.	Modello	Misura	U.M.V.	Imballo
Cod. 29865/01	San Giuseppe	300 x 200	4	20
Cod. 29865/02	Madonna	240 x 180	6	30
Cod. 29865/03	Gesù Bambino	H. 50	10	50
Cod. 29865/06	Pastore	300 x 140	6	30
Cod. 29865/04	Bue	230 x 130	8	40
Cod. 29865/05	Asinello	230 x 150	8	40
Cod. 29865/07	Melchiorre	310 x 140	4	20
Cod. 29865/08	Gasparre	310 x 140	4	20
Cod. 29865/09	Baldassare	240 x 140	6	30



Cod.	Modello	Misura	U.M.V.	Imballo
Cod. 29873/02	Scatola cuore	14 X 18	7	35
Cod. 29873/03	Scatola ovale	150 x 110	8	40
Cod. 29873/04	Scatola quadrata	130 x 130	10	50

Cod.	Modello	Misura	U.M.V.	Imballo
Cod. 29871/01	Portaritratto	145 x 135	12	60
Cod. 29871/02	Portaritratto	240 x 190	10	50
Cod. 29871/03	Portaritratto	270 x 210	8	40
Cod. 29872/01	Cornice	210 x 165	12	60
Cod. 29872/02	Cornice	240 x 170	10	50
Cod. 29872/03	Cornice	320 x 240	8	40

Cod.	Modello	Misura	U.M.V.	Imballo
Cod. 29873/01	Bauletto	150 x 110	10	50
Cod. 29873/05	Scatola rotonda	ø 135	10	50

Cod.	Modello	Misura	U.M.V.	Imballo
Cod. 29875/01	Cane	H. 250	6	30
Cod. 29875/02	Cigno	H. 170	10	50
Cod. 29875/03	Coniglio	H. 250	6	30
Cod. 29875/04	Dinosauro	130 x 250	4	20
Cod. 29875/05	Elefante	100 x 140	4	20
Cod. 29875/06	Gallo	200 x 140	5	25
Cod. 29875/07	Gatto	H. 260	6	30
Cod. 29875/08	Lumaca	210 x 200	6	30
Cod. 29875/09	Orso	H. 260	6	30
Cod. 29875/10	Orso	H. 200	8	40
Cod. 29875/11	Orso	H. 180	10	50
Cod. 29875/12	Papera	160 x 130	10	50
Cod. 29875/13	Tapiro	270 x 220	2	10
Cod. 29875/14	Tartaruga	240 x 90	3	15

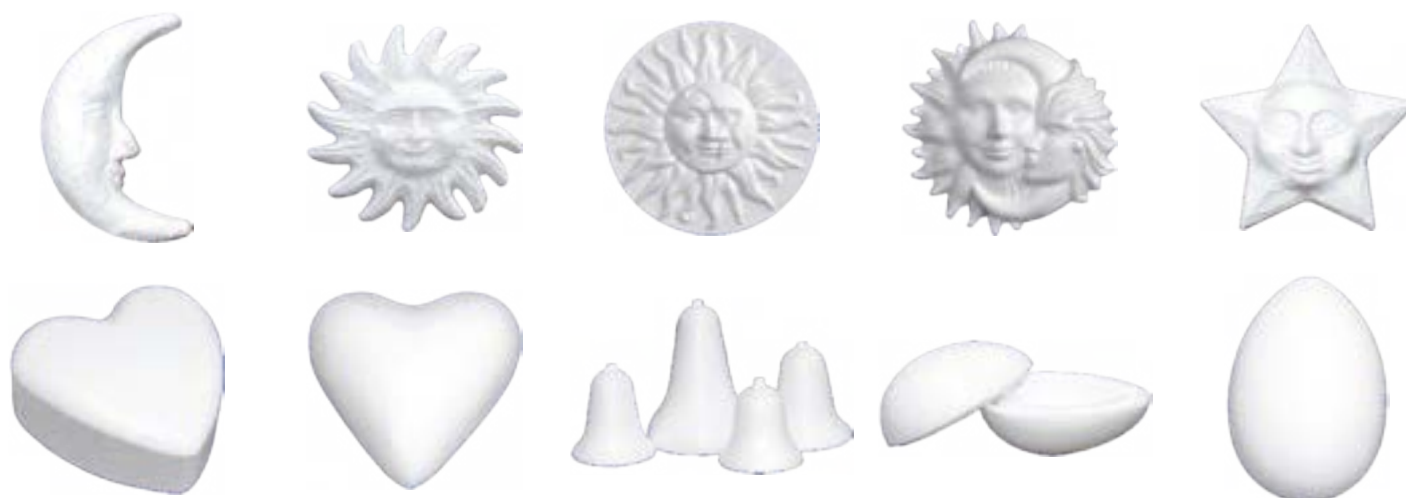

Cod.	Modello	Misura	U.M.V.	Imballo
Cod. 29864/01	Luna piatta	H. 320	10	50
Cod. 29864/02	Sole piatto	ø 440	2	10
Cod. 29864/03	Sole & Luna	ø 390	3	15
Cod. 29864/04	Sole & Luna	ø 260	10	30
Cod. 29864/05	Stella piatta	ø 320	8	80

Cod.	Modello	Misura	U.M.V.	Imballo
Cod. 29868/4	Cuore piatto	140 x 40	50	250
Cod. 29868/5	Cuore piatto	140 x 50	30	150
Cod. 29869/5	Cuore pieno	ø 50	55	275
Cod. 29869/7	Cuore pieno	ø 70	25	125
Cod. 29869/11	Cuore pieno	ø 110	40	200
Cod. 29869/15	Cuore pieno	ø 150	20	100

Cod.	Modello	Misura	U.M.V.	Imballo
Cod. 29867/8	Campana	80 x 80	40	200
Cod. 29867/9	Campana	90 x 90	30	150
Cod. 29867/11	Campana	110 x 110	20	100
Cod. 29867/16	Campana	160 x 160	10	50

Cod.	Modello	Misura	U.M.V.	Imballo
Cod. 29870/6	Uovo	H. 60 ø 40	60	300
Cod. 29870/7	Uovo	H. 70 ø 45	35	175
Cod. 29870/8	Uovo	H. 80 ø 55	25	125
Cod. 29870/10	Uovo	H. 100 70	35	175
Cod. 29870/12	Uovo	H. 120 ø 85	30	150
Cod. 29870/14	Uovo	H. 140 ø 100	20	100
Cod. 29870/15	Uovo apribile	H. 150 ø 110	15	75
Cod. 29870/20	Uovo apribile	H. 200 ø 140	10	50
Cod. 29870/22	Uovo apribile	H. 220 ø 150	8	40
Cod. 29870/24	Uovo apribile	H. 240 ø 170	5	25
Cod. 29870/28	Uovo apribile	H. 280 ø 200	3	15
Cod. 29870/38	Uovo apribile	H. 380 ø 270	2	10



Cod.	Modello	Misura	U.M.V.	Imballo
Cod. 29874/01	Auto	170 x 110	10	50
Cod. 29874/02	Galeone	140 x 170	10	50

Cod.	Modello	Misura	U.M.V.	Imballo
Cod. 29876/01	Mascherina luna	240 x 190	6	30
Cod. 29876/02	Mascherina nastro	240 x 190	6	30

Cod.	Modello	Misura	U.M.V.	Imballo
Cod. 29879	Cappello	H. 100 Ø 290	2	10

Cod.	Modello	Misura	U.M.V.	Imballo
Cod. 29877/ASS	Caratteri	H. 75	52	260

Cod.	Modello	Misura	U.M.V.	Imballo
Cod. 29878/15S1	Lastra	150 x 200 x 10	40	200
Cod. 29878/15S2	Lastra	150 x 200 x 20	20	100
Cod. 29878/20S1	Lastra	200 x 300 x 10	24	120
Cod. 29878/20S2	Lastra	200 x 300 x 20	12	60
Cod. 29878/30S1	Lastra	300 x 400 x 10	12	60
Cod. 29878/30S2	Lastra	300 x 400 x 20	6	30

Cod.	Modello	Misura	U.M.V.	Imballo
Cod. 29866/01	Albero	10 x 50	60	300
Cod. 29866/02	Albero	150 x 90	30	150
Cod. 29866/03	Goccia rigata	110 x 80	40	200
Cod. 29866/04	Sfera diamantata	10 x 9	40	200
Cod. 29866/05	Sfera rigata orizzontale	8 x 8	40	200
Cod. 29866/06	Sfera rigata verticale	8 x 8	40	200
Cod. 29866/07	Trottola rigata	11 x 9	30	150

Shine
glitter glue

METAL E FOSFORESCENTI

Espositore da 12 pezzi, **177 ml**, tappo dosatore per applicazione facilitata.
Prodotto **atossico** e certificato. Confezione da 12 pezzi assortiti.
6 colori metal (**effetto metallizzato**), 6 colori fluorescenti (**brillano al buio**).

Cod. 14595/03

12
U.M.V.

48
Imballo



Shine
glitter glue

CLASSIC

6 colori metallizzati, **177 ml**, tappo dosatore per
applicazione facilitata. Prodotto **atossico** e certificato.
Confezione da 12 pezzi assortiti.

Cod. 14595/01

Cod. 14595/ORO

Cod. 14595/ARG

Cod. 14595/RS



12
U.M.V.

48
Imballo



Shine
glitter glue

FLUO

6 colori fluorescenti, 177 ml, tappo dosatore per applicazione facilitata. Prodotto **atossico** e certificato. Confezione da 12 pezzi assortiti.

Cod. 14595/02



12
U.M.V.

48
Imballo



Shine
glitter glue

SHINE ULTRA

6 colori con paillettes, 125 ml, tappo dosatore per applicazione facilitata. Prodotto **atossico** e certificato. Confezione da 12 pezzi assortiti.

Cod. 14596



12
U.M.V.

48
Imballo





Shine
glitter glue

SHINE

Tubetto **12,5 g**, tappo dosatore per applicazione facilitata. Prodotto **atossico** e certificato. Confezione in barattolo da 50 pezzi assortiti.

Cod. 39566



1
U.M.V.

4
Imballo



Shine
glitter

GLITTER

Barattolo **50 g** a 6 compartimenti con tappo dosatore, espositore 6 pezzi: 3 barattoli colori classici, 3 barattoli **colori fluorescenti**.

Cod. 55402/01

1
U.M.V.

12
Imballo



Shine
glitter

FORMINE

Barattolo **50 g** a 6 compartimenti con tappo dosatore, espositore 6 pezzi: 3 barattoli colori classici, 3 barattoli **colori fluorescenti**. Assortimento cuori, fiori, farfalle, stelle.

Cod. 55402/02

1
U.M.V.

12
Imballo



Sicuri ed igienizzati con Spil!



Igienizzanti

Igienizzanti

IGIENIZZANTI

334

IGIENIZZANTE SPRAY

80 ml, 70 % Alcool.
Pulisce, profuma e igienizza.

Cod. 04983

 12
U.M.V.

 24
Imballo



IGIENIZZANTE GEL

Flacone da 500 ml, 70 % Alcool.

Cod. 56656/500

 1
U.M.V.

 12
Imballo

IGIENIZZANTE GEL

Flacone da **1000 ml**, 70 % Alcool.

Cod. 56656/1000



U.M.V.



Imballo





ABC

Espositori

Espositori

ESPOSITORI

338

EGO



Espositore da banco composto da 24 pezzi:

TACCUINO EGO 13 X 21 CM PUNTEGGIATA, 192 PAGINE, 85 G. 12 PZ
 TACCUINO EGO 13 X 21 CM BIANCA, 192 PAGINE, 85 G. 12 PZ

Cod. 55252/ESP



mémoire



Espositore da banco composto da 15 pezzi:
 TACCUNO MÉMOIRE SP1 FORMATO 13 X 18 CM 3PZ
 TACCUNO MÉMOIRE SP2 FORMATO 13 X 18 CM 3PZ
 TACCUNO MÉMOIRE SP3 FORMATO 13 X 18 CM 3PZ
 TACCUNO MÉMOIRE SP4 FORMATO 13 X 18 CM 3PZ
 TACCUNO MÉMOIRE SP6 FORMATO 13 X 18 CM 3PZ

Cod. 54327/ESP

1
U.M.V.

1
Imballo

SCRITTURA



Cod. 54731/30

1
U.M.V.

1
Imballo

Espositore vuoto, foto puramente indicativa

Magika



Cod. 14470/ASS

1
U.M.V.

1
Imballo

Espositore da banco composto da 300 pezzi:

PENNA CANCELLABILE MAGIKA BLU DA 12
 PENNA CANCELLABILE MAGIKA NERO DA 12
 PENNA CANCELLABILE MAGIKA ROSSO
 PENNA CANCELLABILE MAGIKA VERDE DA 12
 PENNA MAGIKOLOR DA 36 PEZZI ASSORTITI
 REFILL CANCELLABILE MAGIKA BLU DA 3 PEZZI
 REFILL CANCELLABILE MAGIKA NERO DA 3 PEZZI

6 CONF.
 4 CONF.
 6 CONF.
 2 CONF.
 1 DA 36PZ
 24 CONF.
 12 CONF.

REFILL CANCELLABILE MAGIKA ROSSO DA 3 PEZZI
 REFILL CANCELLABILE MAGIKA VERDE DA 3 PEZZI
 PENNA MAGICLIK 0.7 DA 12 PZ BLU
 PENNA MAGICLIK 0.7 DA 12 PZ NERO
 PENNA MAGICLIK 0.7 DA 12 PZ ROSSO
 PENNA MAGICLIK 0.7 DA 12 PZ VERDE
 ESPOSITORE IN PLEXIGLASS DA 30 POSTI

24 CONF.
 6 CONF.
 3 CONF.
 2 CONF.
 3 CONF.
 1 CONF.
 1 PZ

ZERO4

FINELINER 0.4



Cod. 22568/ESP

 1
U.M.V.

 1
Imballo

Espositore da banco composto da 360 pezzi:

ZERO4 GIALLO CHIARO
 ZERO4 GIALLO
 ZERO4 PESCA
 ZERO4 ARANCIONE
 ZERO4 ROSA CARNE
 ZERO4 ROSA
 ZERO4 FUCSIA
 ZERO4 ROSSO
 ZERO4 ACQUAMARINA
 ZERO4 VERDE CHIARO
 ZERO4 VERDE

1 CF DA 12 PZ
 2 CF DA 12 PZ
 1 CF DA 12 PZ
 2 CF DA 12 PZ
 1 CF DA 12 PZ
 2 CF DA 12 PZ
 2 CF DA 12 PZ
 2 CF DA 12 PZ
 1 CF DA 12 PZ
 1 CF DA 12 PZ
 2 CF DA 12 PZ

ZERO4 CIELO
 ZERO4 AZZURRO
 ZERO4 BLU
 ZERO4 LILLA
 ZERO4 OCRA
 ZERO4 MARRONE CHIARO
 ZERO4 MARRONE
 ZERO4 GRIGIO
 ZERO4 NERO
 ESPOSITORE IN PPL DA 30 POSTI

1 CF DA 12 PZ
 1 CF DA 12 PZ
 2 CF DA 12 PZ
 2 CF DA 12 PZ
 1 CF DA 12 PZ
 1 CF DA 12 PZ
 1 CF DA 12 PZ
 1 CF DA 12 PZ
 3 CF DA 12 PZ
 1 PZ

EVIDENZIATORI



Cod. 54731/24

1
U.M.V.

1
Imballo

Espositore vuoto, foto puramente indicativa

MARCATORI



Cod. 54731/21

1
U.M.V.

1
Imballo

Espositore vuoto, foto puramente indicativa

MATI' S201



Cod. 11850/ESP

1
U.M.V.

1
Imballo

Espositore da banco composto da 144 pezzi:

S201 HB	4 CF DA 12
S201 B	2 CF DA 12
S201 H	2 CF DA 12
S201 2H	2 CF DA 12
S201 2B	2 CF DA 12
ESPOSITORE IN PLEXIGLASS DA 12 POSTI	1 PZ

bino PERMANENT INK

DUAL TIP MARKER



Espositore da banco Bino dual tip con punta piatta e fine, marker permanent ink, 360 pezzi assortiti

Cod. 22567/ESP

1
U.M.V.

1
Imballo

bino PERMANENT INK

DUAL TIP MARKER



Espositore da banco Bino dual tip con punta brush e fine, marker permanent ink, 360 pezzi assortiti

Cod. 20306/ESP

1 U.M.V.

12 Imballo



Espositore Spil Luminoso

Cod. 57595

1
U.M.V.

1
Imballo

TEKNO



Cod. 54817/ESP



Espositore da banco in cartone composto da:

RIGA 50 CM	20 PZ	DOPPIO DECIMETRO	20 PZ
RIGA 60 CM	20 PZ	TRIPLO DECIMETRO	20 PZ
SQUADRA 32 CM/45°	20 PZ	GONIOMETRO 180°	20 PZ
SQUADRA 32 CM/60°	20 PZ	GONIOMETRO 360°	20 PZ
SQUADRA 36 CM/45°	20 PZ	COPPIA SQUADRE 16 CM	20 PZ
SQUADRA 36 CM/60°	20 PZ		

SpilBlok®

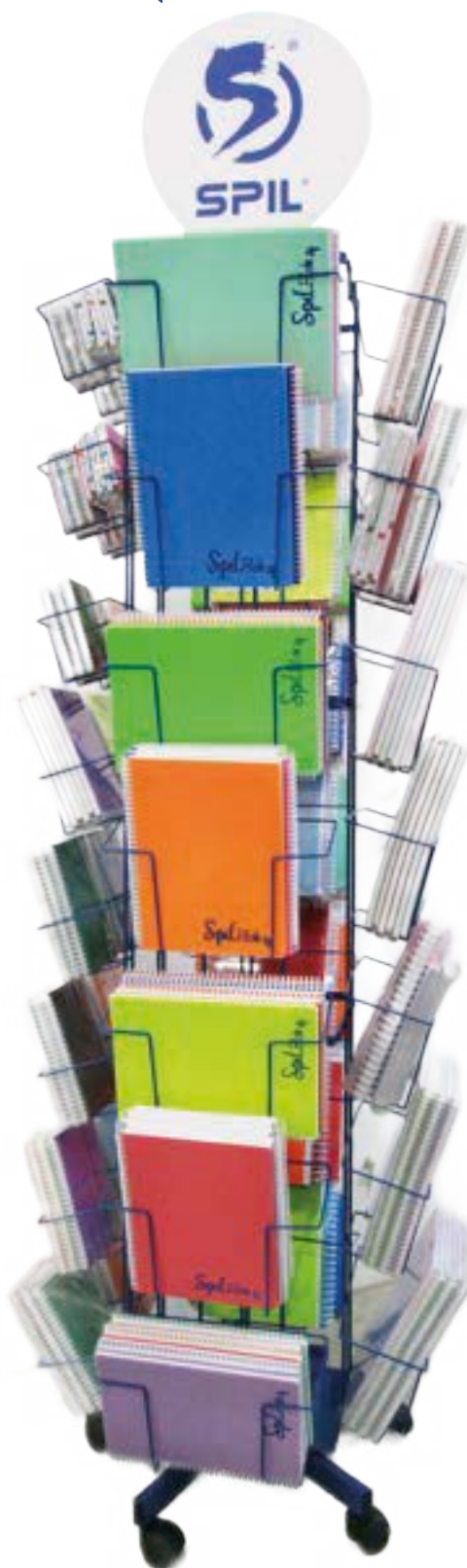

Cod. 07992/G

 1
U.M.V.

 1
Imballo

Espositore SpilBlok girevole in metallo con route orientabili.

SpilBlok®



Cod. 54731/BIANCO

 1
U.M.V.

 1
Imballo

Espositore SpilBlok in cartone da banco.

COLLA



Cod. 57622/TERRA



Espositore da terra in legno composto da:

GLITTER GLUE SHINE CLASSIC	24 PZ	COLLA STICK 7 MM PER COLLA A CALDO	12 PZ
GLITTER GLUE SHINE FLUO	12 PZ	PISTOLA TERMOFUSONE ø 7	8 PZ
GLITTER GLUE NEON/METAL	24 PZ	PISTOLA TERMOFUSONE ø 11	4 PZ
GLITTER GLUE SHINE ULTRA	12 PZ	COLLA A NASTRO PICIKO	24 PZ
GLITTER CLASSIC/NEON DA	1 CONF. DA 6 PZ	COLLA VINYL 250 GR	24 PZ
FORMINE CLASSIC/NEON	1 CONF. DA 6 PZ	COLLA VINYL 1 KG	4 PZ
COLLA ARTS & CRAFT LIQUIDA	24 PZ	COLLA VINYL PRONTO 100 G	24 PZ
GLITTER GLUE DA 12,5 GR IN BARATTOLO	3 PZ	COLLA VINYL PRONTO 250 G	8 PZ
COLLA GELSTIK 10 GR	120 PZ	COLLA VINYL PRONTO 1 KG	4 PZ
COLLA GELSTIK 20 GR	96 PZ	GOMMINO TRIATAK 10 MM	48 PZ
COLLA GELSTIK 40 GR	72 PZ	GOMMINO TRIATAK 20 MM	48 PZ
COLLA IZISTIK 15 G	120 PZ	COLLA SUPER GLUE	12 PZ
COLLA LIQUIDA INSTACOL	48 PZ	ESPOSITORE IN LEGNO DA TERRA	1 PZ
COLLA STICK 11 MM PER COLLA A CALDO	2 PZ		

ETICHETTE



Cod. 19784/ESP

1
U.M.V.

1
Imballo

Espositore in cartone da banco composto da:

FORMATO 34*5 10 FF DA 60 ETICHETTE
 FORMATO 56*10 10 FF DA 24 ETICHETTE
 FORMATO 46*27 10 FF DA 12 ETICHETTE
 FORMATO 58*27 10 FF DA 10 ETICHETTE
 FORMATO 56*34 10 FF DA 8 ETICHETTE
 FORMATO 70*27 10 FF DA 8 ETICHETTE

1 CF DA 25 PZ
 1 CF DA 25 PZ
 1 CF DA 25 PZ
 1 CF DA 25 PZ
 1 CF DA 25 PZ
 1 CF DA 25 PZ

FORMATO 73*37 10 FF DA 6 EICHETTE
 FORMATO 70*56 10 FF DA 4 ETICHETTE
 FORMATO 83*53 10 FF DA 3 ETICHETTE
 FORMATO 110*34 10 FF DA 4 ETICHETTE
 FORMATO 100*46 10 FF DA 3 ETICHETTE
 FORMATO 115*70 10 FF DA 2 ETICHETTE

1 CF DA 25 PZ
 1 CF DA 25 PZ
 1 CF DA 25 PZ
 1 CF DA 25 PZ
 1 CF DA 25 PZ
 1 CF DA 25

RACCOGLITORE 4 ANELLI FLUO



Cod. 27210



1

U.M.V.



1

Imballo

Espositore in cartone da banco composto da 30 pezzi:

RACCOGLITORE 18,5 X 23 Ø16

RACCOGLITORE 18,5 X 23 Ø30

RACCOGLITORE 18,5 X 23 Ø16

18 PZ COLORI FLUO

6 PZ COLORI FLUO

6 PZ COLORI FLUO

RACCOGLITORE 4 ANELLI TRASLUCIDO



Cod. 27205



Espositore in cartone da banco composto da 30 pezzi:

RACCOGLITORE 18,5 X 23 Ø16
 RACCOGLITORE 18,5 X 23 Ø30
 RACCOGLITORE 18,5 X 23 Ø16

18 PZ COLORI TRASLUCIDI
 6 PZ COLORI TRASLUCIDI
 6 PZ COLORI TRASLUCIDI

RACCOGLITORE "TOUCH" 4 ANELLI



Cod. 09235/ESP

 1
U.M.V.

 1
Imballo

Espositore in cartone da banco composto da 30 pezzi:

RACCOGLITORE Ø16	15 PZ
RACCOGLITORE Ø30	15 PZ

BUSTE CON ZIP



Cod. 07901/ESP



Espositore in cartone da banco composto da 108 pezzi:

FORMATO A3
FORMATO A4
FORMATO A5

3 CF DA 12 PZ
3 CF DA 12 PZ
3 CF DA 12 PZ

BUSTE CON BOTTONE TRASLUCIDE



Cod. 19705/ESP



Espositore in cartone da banco composto da 120 pezzi:

FORMATO A4	2 CF DA 12 PZ COLORI TRASLUCIDI
FORMATO A5	2 CF DA 12 PZ COLORI TRASLUCIDI
FORMATO A6	2 CF DA 12 PZ COLORI TRASLUCIDI
FORMATO A7	2 CF DA 12 PZ COLORI TRASLUCIDI
FORMATO 10*22	2 CF DA 12 PZ COLORI TRASLUCIDI

BUSTA CON BOTTONE OPACHE



Cod. 09231/ESP

 1
U.M.V.

 4
Imballo

Espositore in cartone da banco composto da:

FORMATO A4
FORMATO A5
FORMATO A6
FORMATO A7
FORMATO 10*22

2 CF DA 12 PZ COLORI OPACHI
2 CF DA 12 PZ COLORI OPACHI
2 CF DA 12 PZ COLORI OPACHI
2 CF DA 12 PZ COLORI OPACHI
2 CF DA 12 PZ COLORI OPACHI

BUSTA CON BOTTONE FLUO



Cod. 19706/ESP

 1
U.M.V.

 4
Imballo

Espositore in cartone da banco composto da 120 pezzi:

FORMATO A4
FORMATO A5
FORMATO A6
FORMATO A7
FORMATO 10*22

2 CF DA 12 PZ COLORI FLUORESCENTI
2 CF DA 12 PZ COLORI FLUORESCENTI
2 CF DA 12 PZ COLORI FLUORESCENTI
2 CF DA 12 PZ COLORI FLUORESCENTI
2 CF DA 12 PZ COLORI FLUORESCENTI

PORTACARDS



Espositore in cartone da banco portadocumenti

Cod. 54731/BIANCO

1
U.M.V.

1
Imballo



Modulo Ordini

MODULO ORDINI

364

SOMMARIO

SCRITTURA (1) 1

PENNE	2
EVIDENZIATORI	17
PENNARELLI.....	26
CORRETTORI.....	34

DISEGNO (2) 37

COLORI	38
MATITE.....	47
TEMPERAMATITE	50
GOMME.....	53
BLOCCHI DISEGNO.....	56
SQUADRE-RIGHE	58
COMPASSI.....	64
FORBICINE	74
CARTELLE PORTA DISEGNI ...	76

CARTOTECNICA (3) 81

MAXI QUADERNO MONOCOLORE	84
MAXI QUADERNO CARTONATO	89
QUADERNI A5.....	89
RUBRICHE	90
RICAMBI	91
MAXI QUADERNO MUSICA.....	92
QUADERNI LABORATORIO.....	93
CARTA PROTOCOLLO.....	94
SPILNOTES.....	95
PORTA BLOCCHI	98

SPILBLOK (4) 101

SPILBLOK4.....	106
SPILBLOKQ	109
SPILBLOK5.....	113
SPILBLOK6.....	113
SPILBLOK7.....	113
SPILBLOK9.....	114
SPILBLOK1.....	117

SPILBLOK2.....	117
----------------	-----

COPRILIBRI E COPRIMAXI (5) 121

COPRILIBRI	122
COPRIMAXI.....	123
ETICHETTE PER LIBRI.....	124

CALCOLATRICI (6) 127

TASCABILI.....	128
DA BANCO	132
SCIENTIFICHE.....	135

DIDATTICA (7) 139

FORBICINE.....	140
ABACO	142
REGOLI.....	142
BLOCCHI LOGICI.....	143

COLLE E COLLANTI (8) 145

GEL STIK.....	146
COLLA VINYL.....	146
COLLA LIQUIDA	147
COLLA GLITTER	148
GLITTER.....	150
SUPER GLUE	151
TRA TAK.....	151
PICIKO.....	151
PISTOLA A CALDO	152
NASTRO TRASPARENTE	154
NASTRO IMBALLO	155
DISPENSER.....	156
NASTRO BIADESIVO	157
NASTRO INVISIBILE	158
NASTRO CARTA.....	158
NASTRO ISOLANTE	158
NASTRO TELATO.....	159
NASTRO SEGNALATORE	159
ETICHETTE IN BUSTA.....	160
ETICHETTE IN A4.....	162
PREZZATRICI	166

IMBALLAGGIO (9)

PLURIBALL.....	170
FILM ESTENSIBILE.....	170
CARTA DA IMBALLO.....	171

CUBOTTI E STIKI MEMO (10)

BLOCCHI NUMERATI.....	174
PLANNING.....	174
Q.BO.....	174
SEGNA PAGINE.....	175
STIKI MEMO.....	176

SPILLATRICI E**ACCESSORI (11)**

SPILLATRICI.....	182
PUNTI PER SPILLATRICI.....	185
LEVAPUNTI.....	186
PERFORATORI.....	187
FORBICI.....	188
CUTTER.....	189
FERMAGLI.....	190
PUNTINE.....	190
SPILLI CARTOGRAFICI.....	191
BINDER CLIP.....	191
UMIDIFICATORE.....	191

ACCESSORI (12)

CARTELLI VARI.....	194
CARTELLI SEGNA PREZZO.....	195
ELASTICI.....	197
PORTA BLOCCHI.....	198
ELIMINA CODE.....	200
REGGI LIBRI.....	202
PREZZATRICI.....	203
UMIDIFICATORE.....	205

ARCHIVIO (13)

PORTA PROGETTO.....	208
CARTELLE ELASTICO.....	210
CARTELLE A SCOMPARTI.....	213
CARTELLE CON LEMBI.....	214
CARTELLE SENZA LEMBI.....	215
CARTELLE CON FINESTRA.....	215
CARTELLE PRODUZIONE.....	215
CARTELLE CON ANELLI.....	216

BUSTE CON FORATURA

UNIVERSALE.....	220
BUSTE TRASPARENTI AD L.....	221
DIVISORI ED INTERCALARI.....	221
BUSTE CON BOTTONE.....	222
BUSTE CON ZIP.....	224
PORTA TESINA.....	226
PORTA LISTINI.....	226
PORTA DOCUMENTI ITALY.....	228
PORTA DOCUMENTI CLASSIC.....	229
CARTELLE CON LEGACCIO....	230
CARTELLE SOSPESE.....	231

LAVAGNE (14)

LAVAGNE MAGNETICHE.....	234
LAVAGNE IN SUGHERO.....	236
PENNARELLI PER LAVAGNE....	237
SPILLI CARTOGRAFICI.....	238
CANCELLINI.....	238

PORTA DOCUMENTI (15)

PORTA CARDS.....	242
ETICHETTE PER BAGAGLI.....	250
PORTA DOCUMENTI.....	251

CARTE SPECIALI (16)

CARTONCINI CHARTAE.....	256
CARTONCINI GOFFRATI.....	256
CARTA PERGAMENATA.....	257
CARTONCINI MOMENTI.....	258

RILEGATURA (17)

COPERTINE IN PVC.....	262
POUCHES PER PLASTIFICAZIONE.....	262
NASTRO INVISIBILE.....	263
NASTRO TELATO.....	263
RILEGATRICE.....	264
DORSINI IN PLASTICA.....	265
SPIRALI IN PLASTICA.....	266

CARTA E ROTOLI (18)

CARTA PER FOTOCOPIE.....	274
ROTOLE PER CASSA.....	275
ROTOLE PER POS.....	275

ROTOLO PER PLOTTER.....	276
ROTOLO PER XEROX.....	276
OPALINE E	
BUSTE PER SPEDIZIONE (19)	279
OPALINE	280
BUSTE IMBOTTITE.....	285
BUSTE SPEDIZIONE.....	286
CORNICI (20)	291
CORNICI A GIORNO	292
CORNICI PIATTINA.....	292
CORNICI ARTE POVERA	293
CORNICI BURN.....	293
CONFEZIONAMENTO (21)	295
BUSTE DA REGALO	296
BUSTE PORTA BOTTIGLIE	303
SCATOLE DA REGALO	305
CARTA DA IMBALLO	307
PALLONCINI (22)	309
PALLONCINI AD ELIO	310
PALLONCINI AD ARIA.....	310
PALLONCINI MODELLABILI.....	312
HOBBISTICA (23)	315
FORME IN PLASTICA	316
FORME IN POLISTIROLO	321
COLLE GLITTER.....	328
GLITTER.....	331
IGIENIZZANTI (24)	333
ESPOSITORI (25)	337
MODULO ORDINI (26)	363

