

# Spil<sup>®</sup>Blok





**QUALUNQUE SIA LA TUA ESIGENZA, C'È UNO  
SPILBLOK ADATTO A TE:  
FLUO, PASTEL, DOTTED, BIG, CLASSIC.**

Tutti noi abbiamo le nostre preferenze quando si tratta di quaderni.

Alcuni cercano qualcosa di bello e comodo su cui scrivere, mentre altri cercano un quaderno particolare, grande, con molto spazio per i loro appunti.

Gli spilblok sono i quaderni ideali per tutti!





## *spirale*

---

La spirale in metallo plastificato consente una corretta sovrapposizione delle pagine ed evita che queste si sporchino al contatto con le mani.



## *cartoncino*

---

Il cartoncino posteriore da 900 gr. consente una maggiore stabilità di scrittura quando non si ha la possibilità di poggiarsi su una base solida.



## *fogli*

I fogli dei nostri Spilblok sono da 80 gr/m<sup>2</sup>, microperforati con invito allo strappo, senza fori e con fori per poter essere archiviati in raccoglitori ad anello.



## *elastico*

Gli Spilblok della serie "e" sono provvisti di un elastico a chiusura per una migliore tenuta del quaderno nella borsa o nello zaino.

# SpilBlok® 4 pastel



## COLORI ASSORTITI\*



Giallo



Lilla



Verde  
acqua



Rosso



Celeste



Arancione

\*Colori non acquistabili singolarmente

## Formato A4

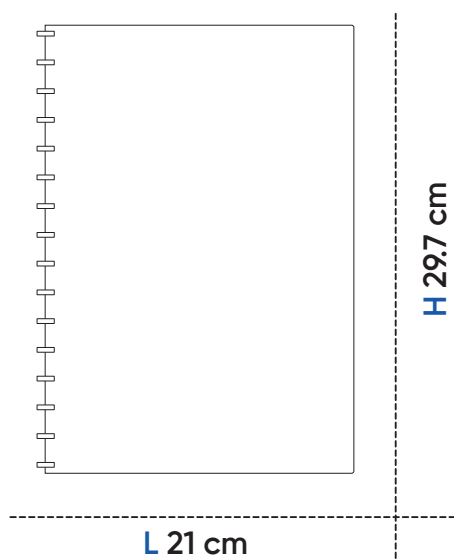

## Grammatura 80 gr/m<sup>2</sup>

## Fogli 80



### Codice

55225/CF

55225/SF

55226/CF

55226/SF

55227/CF

55227/SF

55228

### Rigatura

1R

1R

5 mm

5 mm

4 mm

4 mm

Bianco

### Foratura

Con 4 fori

Senza fori

Con 4 fori

Senza fori

Con 4 fori

Senza fori

Senza fori

### Imballo

30

30

30

30

30

30

30

### U.M.V

6

6

6

6

6

6

6



# SpilBlok<sup>®</sup> 4big pastel



## COLORI ASSORTITI\*



Giallo



Lilla



Verde  
acqua



Rosso



Celeste



Arancione

\*Colori non acquistabili singolarmente

## Formato

### A4

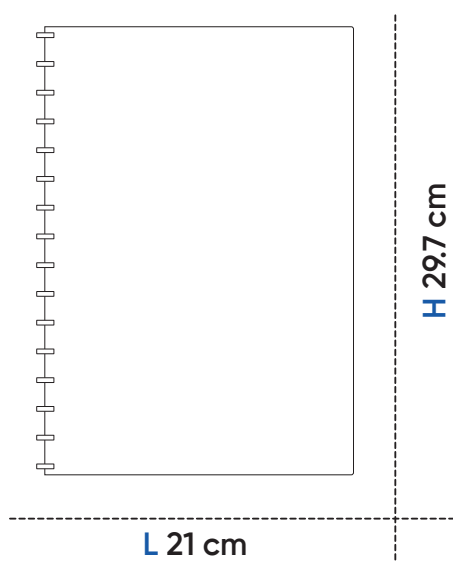

## Grammatura

### 80 gr/m<sup>2</sup>

## Fogli

### 144



### Codice

55229/CF

55229/SF

55230/CF

55230/SF

### Rigatura

1R

1R

5 mm

5 mm

### Foratura

Con 4 fori

Senza fori

Con 4 fori

Senza fori

### Imballo

20

20

20

20

### U.M.V

2

2

2

2

# SpilBlok<sup>®</sup> 4S pastel



## COLORI ASSORTITI\*



Giallo



Lilla



Verde  
acqua



Rosso



Celeste



Arancione

\*Colori non acquistabili singolarmente

## Formato

### A4

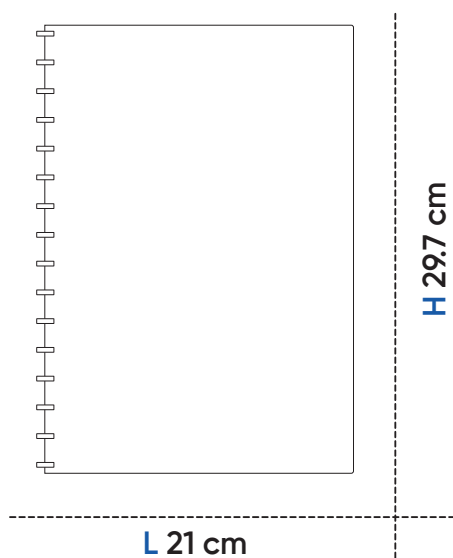

## Grammatura

80 gr/m<sup>2</sup>

## Fogli

150

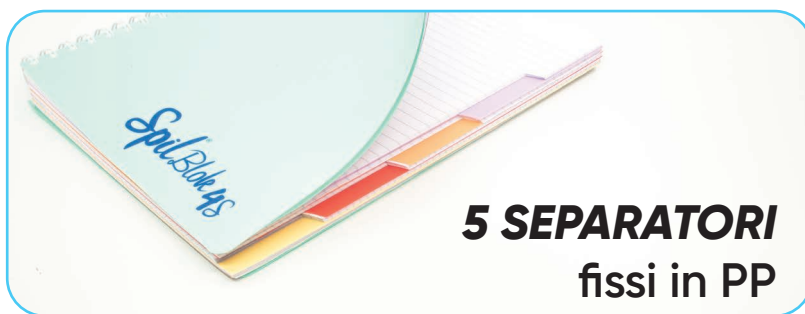

### Codice

55231

55232

55233

### Rigatura

1R

5 mm

1R - 5 mm - Bianco

### Foratura

Senza fori

Senza fori

Senza fori

### Imballo

20

20

20

### U.M.V

2

2

2

# SpilBlok<sup>®</sup> 4 dotted

## COLORI ASSORTITI\*



Rosso



Nero



Blu



Giallo



Verde



Arancione

\*Colori non acquistabili singolarmente

**COPERTINA**  
in PP a nido d'ape

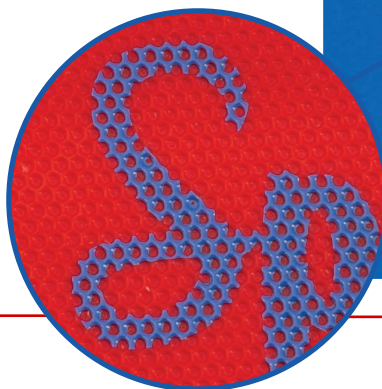

**Formato**  
A4

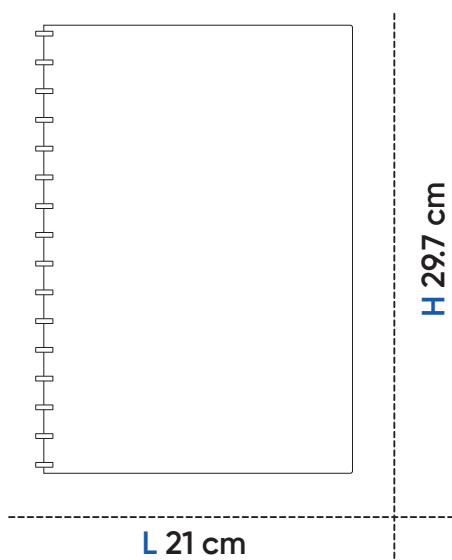

**Grammatura**  
80 gr/m<sup>2</sup>

**Fogli**  
80



### Codice

55236/CF

55236/SF

55237/CF

55237/SF

55460/CF

55460/SF

55238

### Rigatura

1R

1R

5 mm

5 mm

4 mm

4 mm

Bianco

### Foratura

Con 4 fori

Senza fori

Con 4 fori

Senza fori

Con 4 fori

Senza fori

Senza fori

### Imballo

30

30

30

30

30

30

30

### U.M.V

6

6

6

6

6

6

6

# SpilBlok<sup>®</sup> 4big dotted



## COLORI ASSORTITI\*



Rosso



Nero



Blu



Giallo



Verde



Arancione

\*Colori non acquistabili singolarmente

## Formato

### A4

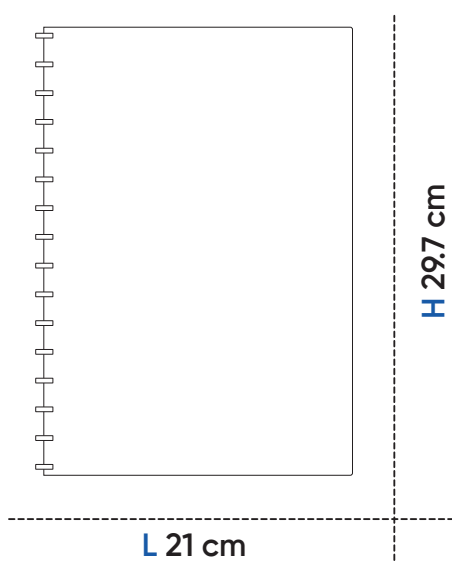

## Grammatura

### 80 gr/m<sup>2</sup>

## Fogli

### 144



### Codice

55239/CF

55239/SF

55240/CF

55240/SF

56124

56124

### Rigatura

1R

1R

5 mm

5 mm

Bianco

Bianco

### Foratura

Con 4 fori

Senza fori

Con 4 fori

Senza fori

Con 4 fori

Senza fori

### Imballo

20

20

20

20

20

20

### U.M.V

2

2

2

2

2

2

# SpilBlok<sup>®</sup> 4s dotted



## COLORI ASSORTITI\*



Rosso



Nero



Blu



Giallo



Verde



Arancione

\*Colori non acquistabili singolarmente

## Formato

### A4

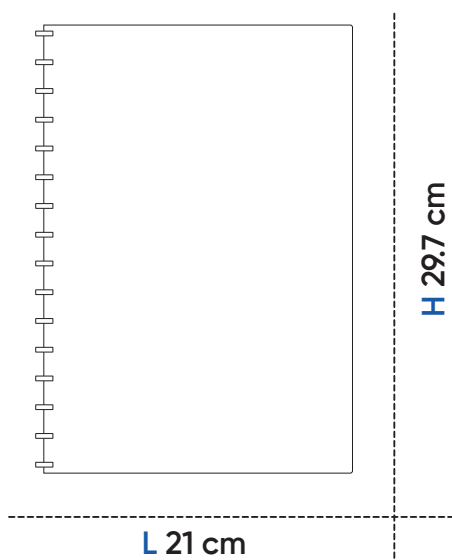

## Grammatura

### 80 gr/m<sup>2</sup>



## Fogli

### 150



**5 SEPARATORI**  
fissi in PP

### Codice

55241

55242

55243

### Rigatura

1R

5 mm

1R - 5 mm - Bianco

### Foratura

Senza fori

Senza fori

Senza fori

### Imballo

20

20

20

### U.M.V

2

2

2

# SpilBlok 4<sup>®</sup> fluo



## COLORI ASSORTITI\*



Giallo



Viola



Verde



Fucsia



Blu



Arancione

\*Colori non acquistabili singolarmente

## Formato

### A4

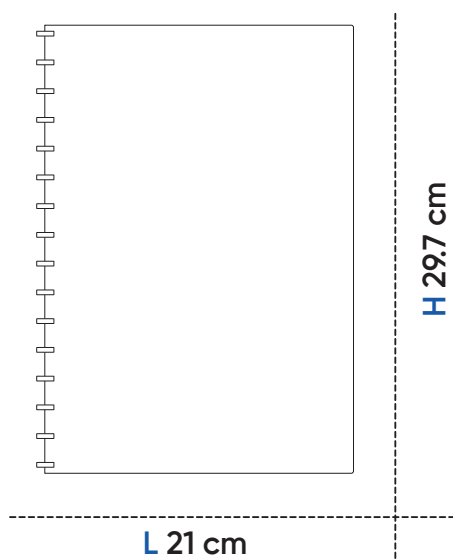

## Grammatura

### 80 gr/m<sup>2</sup>

## Fogli

### 80



### Codice

19712/CF

19712/SF

19713/CF

19713/SF

10728/CF

10728/SF

27610

28615/SF

### Rigatura

1R

1R

5 mm

5 mm

4 mm

4 mm

Bianco

10 mm

### Foratura

Con 4 fori

Senza fori

Con 4 fori

Senza fori

Con 4 fori

Senza fori

Senza fori

Senza fori

### Imballo

30

30

30

30

30

30

30

30

### U.M.V

6

6

6

6

6

6

6

6

# SpilBlok® 4big fluo



## COLORI ASSORTITI\*



Giallo



Viola



Verde



Fucsia



Blu



Arancione

\*Colori non acquistabili singolarmente

## Formato

### A4

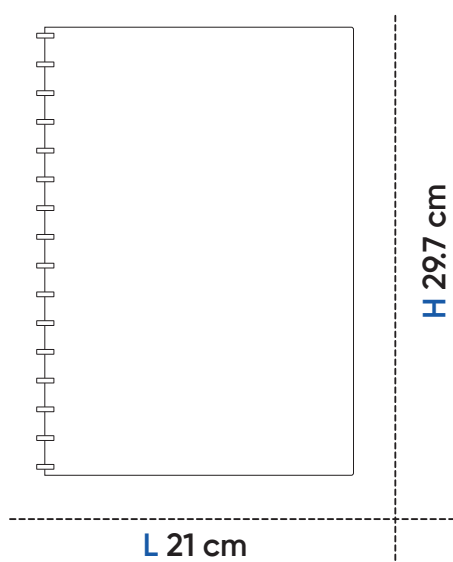

## Grammatura

### 80 gr/m<sup>2</sup>

## Fogli

### 144



### Codice

19710/CF

19710/SF

19711/CF

19711/SF

27611

22608/SF

### Rigatura

1R

1R

5 mm

5 mm

Bianco

4 mm

### Foratura

Con 4 fori

Senza fori

Con 4 fori

Senza fori

Senza fori

Senza fori

### Imballo

20

20

20

20

20

20

### U.M.V

2

2

2

2

2

2

# SpilBlok 4s fluo



## COLORI ASSORTITI\*



Giallo



Viola



Verde



Fucsia



Blu



Arancione

\*Colori non acquistabili singolarmente

## Formato

A4

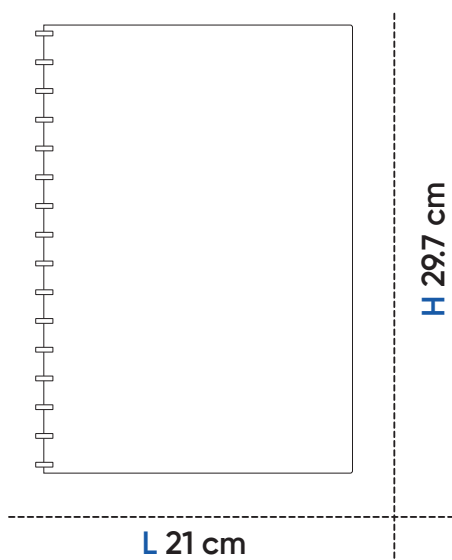

## Grammatura

80 gr/m<sup>2</sup>

## Fogli

150



**5 SEPARATORI**  
fissi in PP

### Codice

23036

### Rigatura

1R

### Foratura

Senza fori

### Imballo

20

### U.M.V

2

23037

5 mm

Senza fori

20

2

23081

1R - 5 mm - Bianco

Senza fori

20

2

22594

4 mm

Senza fori

20

2



# SpilBlok 4D<sup>®</sup>

## COLORI ASSORTITI\*



\*Colori non acquistabili singolarmente

**TASCA**  
portafogli



**Formato**  
**A4**

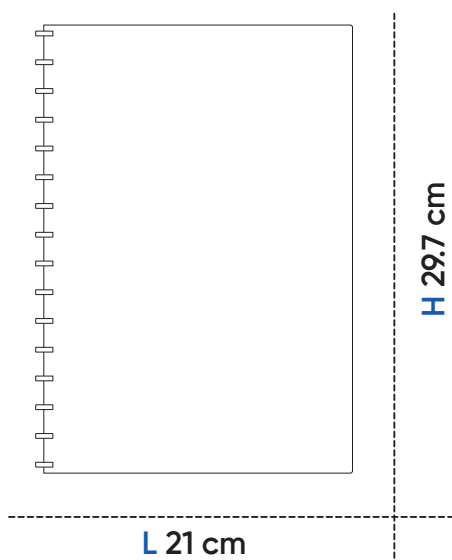

**Grammatura**  
80 gr/m<sup>2</sup>

**Fogli**  
80



**1 SEPARATORE**  
rimovibile in PP

### Codice

23034/CF

23034/SF

23035/CF

23035/SF

### Rigatura

1R

1R

5 mm

5 mm

### Foratura

Con 4 fori

Senza fori

Con 4 fori

Senza fori

### Imballo

36

36

36

36

### U.M.V

6

6

6

6



### COLORI ASSORTITI\*



\*Colori non acquistabili singolarmente



### Formato

19 x 26

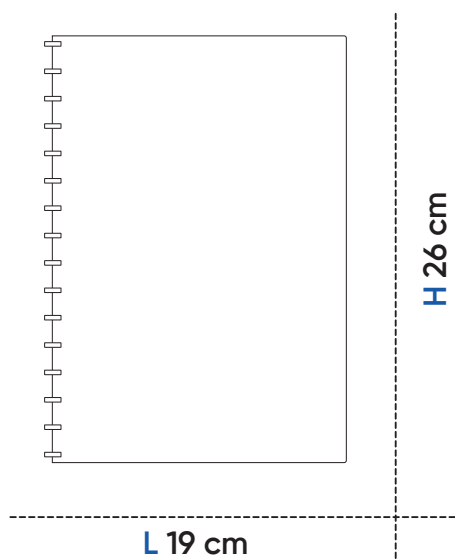

### Grammatura

80 gr/m<sup>2</sup>

### Fogli

80

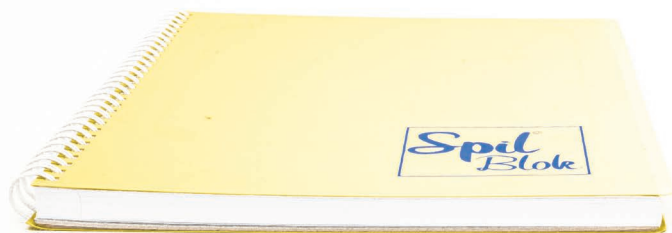

### Codice

26518

26519

29311

### Rigatura

1R

5 mm

4 mm

### Foratura

Senza fori

Senza fori

Senza fori

### Imballo

36

36

36

### U.M.V

6

6

6

# SpilBlok<sup>®</sup> 4+ pastel



## COLORI ASSORTITI\*



Giallo



Lilla



Verde  
acqua



Rosso



Celeste



Arancione

\*Colori non acquistabili singolarmente

**Formato**  
22.5 x 29.7

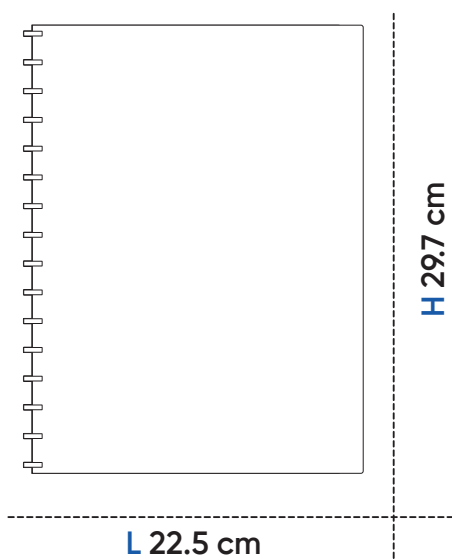

**Grammatura**  
80 gr/m<sup>2</sup>

**Fogli**  
80



### Codice

18553/CF

18553/SF

18554/CF

18554/SF

### Rigatura

1R

1R

5 mm

5 mm

### Foratura

Con 4 fori

Senza fori

Con 4 fori

Senza fori

### Imballo

36

36

36

36

### U.M.V

6

6

6

6

# SpilBlok® 4big+ pastel



## COLORI ASSORTITI\*



Giallo



Lilla



Verde  
acqua



Rosso



Celeste



Arancione

\*Colori non acquistabili singolarmente

## Formato

22.5 x 29.7

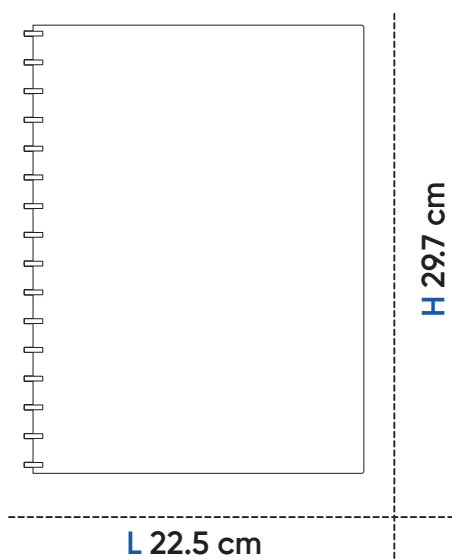

## Grammatura

80 gr/m<sup>2</sup>

## Fogli

144



### Codice

18556/CF

18556/SF

18558/CF

18558/SF

### Rigatura

1R

1R

5 mm

5 mm

### Foratura

Con 4 fori

Senza fori

Con 4 fori

Senza fori

### Imballo

20

20

20

20

### U.M.V

2

2

2

2

# SpilBlok<sup>®</sup> 4S+ pastel



## COLORI ASSORTITI\*



Giallo



Lilla



Verde  
acqua



Rosso



Celeste



Arancione

\*Colori non acquistabili singolarmente

## Formato

22.5 x 29.7

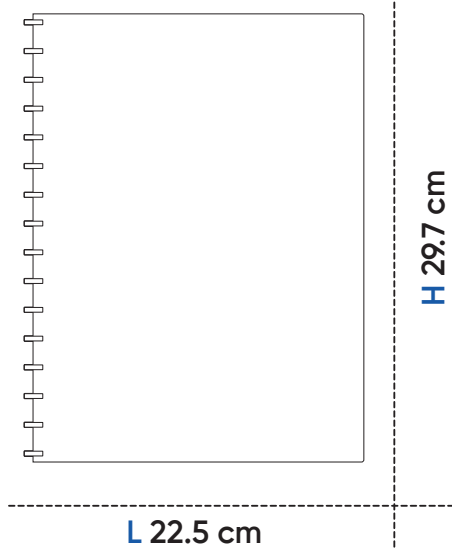

## Grammatura

80 gr/m<sup>2</sup>

## Fogli

150



## Codice

18559/1R

18559/5MM

18559/ASS

## Rigatura

1R

5 mm

1R - 5 mm - Bianco

## Foratura

Senza fori

Senza fori

Senza fori

## Imballo

20

20

20

## U.M.V

2

2

2

# SpilBlok<sup>®</sup> 4+ dotted

## COLORI ASSORTITI\*



Rosso



Nero



Blu



Giallo



Verde



Arancione

\*Colori non acquistabili singolarmente

## COPERTINA

in PP a nido d'ape

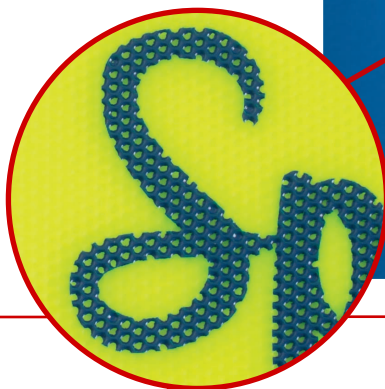

## Formato

22.5 x 29.7

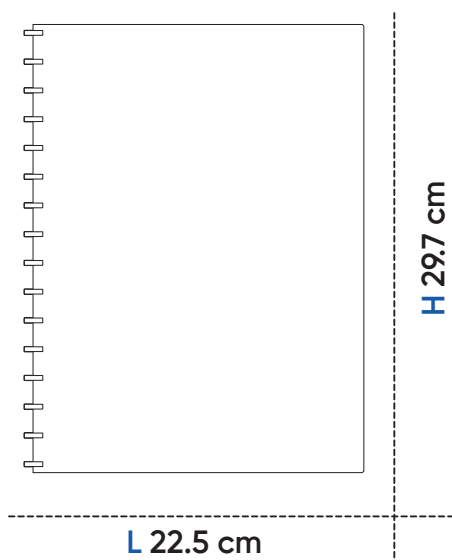

## Grammatura

80 gr/m<sup>2</sup>

## Fogli

80



### Codice

19657/CF

19657/SF

19658/CF

19658/SF

### Rigatura

1R

1R

5 mm

5 mm

### Foratura

Con 4 fori

Senza fori

Con 4 fori

Senza fori

### Imballo

36

36

36

36

### U.M.V

6

6

6

6

# SpilBlok® 4big+ dotted



## COLORI ASSORTITI\*



Rosso



Nero



Blu



Giallo



Verde



Arancione

\*Colori non acquistabili singolarmente

## Formato

22.5 x 29.7

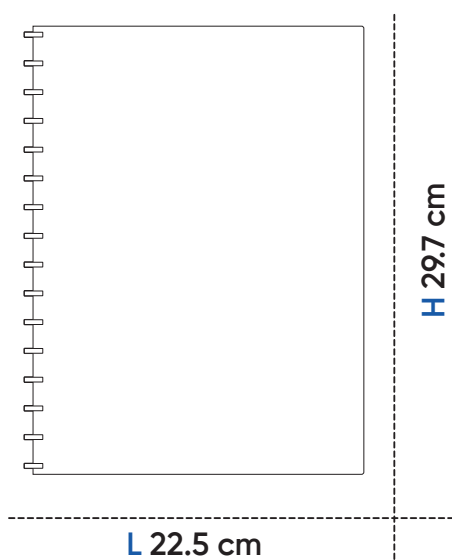

## Grammatura

80 gr/m<sup>2</sup>

## Fogli

144

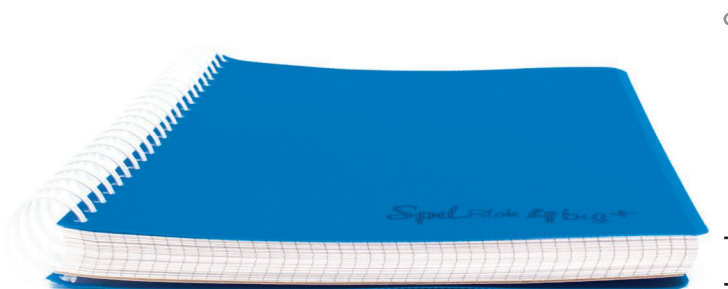

### Codice

19659/CF

19659/SF

19660/CF

19660/SF

### Rigatura

1R

1R

5 mm

5 mm

### Foratura

Con 4 fori

Senza fori

Con 4 fori

Senza fori

### Imballo

20

20

20

20

### U.M.V

2

2

2

2

# SpilBlok® 4S+ dotted



## COLORI ASSORTITI\*



\*Colori non acquistabili singolarmente

**Formato**  
22.5 x 29.7

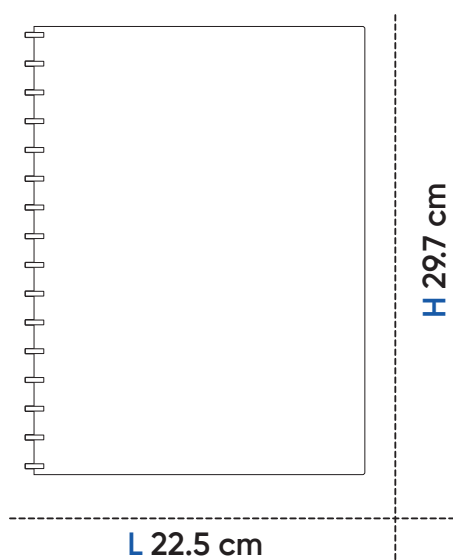

**Grammatura**  
80 gr/m<sup>2</sup>

**Fogli**  
150



**5 SEPARATORI**  
fissi in PP

Codice	Rigatura	Foratura	Imballo	U.M.V
19665/1R	1R	Senza fori	20	2
19665/5MM	5 mm	Senza fori	20	2
19665/ASS	1R - 5 mm - Bianco	Senza fori	20	2



# SpilBlok<sup>®</sup> 4+ fluo



## COLORI ASSORTITI\*



Giallo



Viola



Verde



Fucsia



Blu



Arancione

\*Colori non acquistabili singolarmente

## Formato

22.5 x 29.7

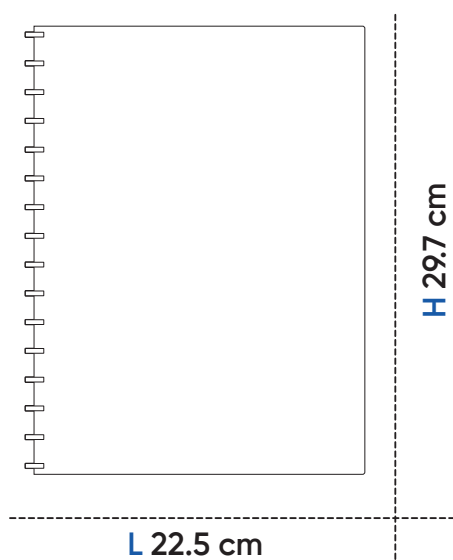

## Grammatura

80 gr/m<sup>2</sup>

## Fogli

80



### Codice

19929/CF

19929/SF

19930/CF

19930/SF

### Rigatura

1R

1R

5 mm

5 mm

### Foratura

Con 4 fori

Senza fori

Con 4 fori

Senza fori

### Imballo

36

36

36

36

### U.M.V

6

6

6

6

# SpilBlok® 4big+ fluo



## COLORI ASSORTITI\*



Giallo



Viola



Verde



Fucsia



Blu



Arancione

\*Colori non acquistabili singolarmente

## Formato

22.5 x 29.7

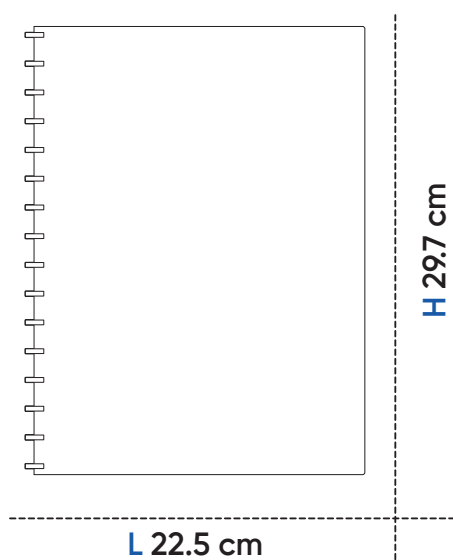

## Grammatura

80 gr/m<sup>2</sup>

## Fogli

144



### Codice

19931/CF

19931/SF

19932/CF

19932/SF

### Rigatura

1R

1R

5 mm

5 mm

### Foratura

Con 4 fori

Senza fori

Con 4 fori

Senza fori

### Imballo

20

20

20

20

### U.M.V

2

2

2

2

# SpilBlok 4S+ fluo



## COLORI ASSORTITI\*



Giallo



Viola



Verde



Fucsia



Blu



Arancione

\*Colori non acquistabili singolarmente

## Formato

22.5 x 29.7

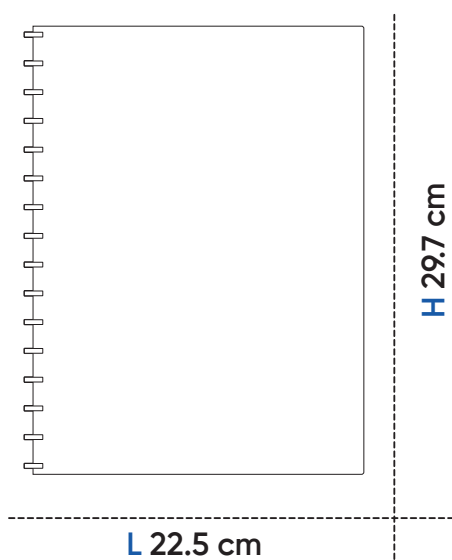

## Grammatura

80 gr/m<sup>2</sup>

## Fogli

150



**5 SEPARATORI**  
fissi in PP

### Codice

19940/1R

19940/5MM

19940/ASS

### Rigatura

1R

5 mm

1R - 5 mm - Bianco

### Foratura

Senza fori

Senza fori

Senza fori

### Imballo

20

20

20

### U.M.V

2

2

2

# SpilBlok<sup>®</sup> 5



## COLORI ASSORTITI\*



\*Colori non acquistabili singolarmente

**Formato**  
**A5**

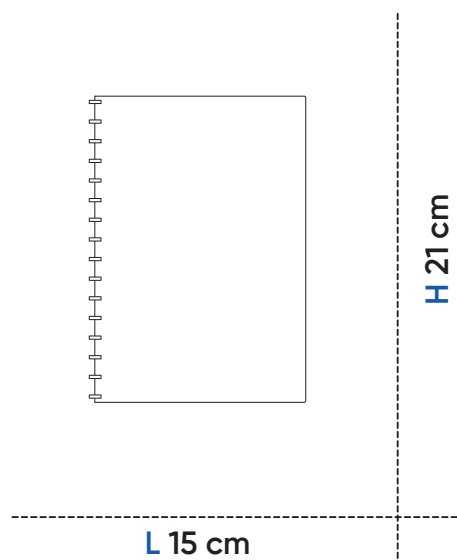

**Grammatura**  
**80 gr/m<sup>2</sup>**

**Fogli**  
**80**

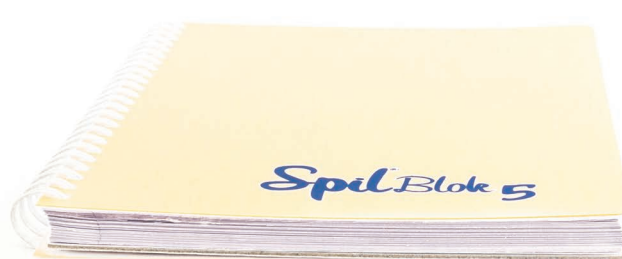

### Codice

19714/CF

19714/SF

19715/CF

19715/SF

22597/CF

22597/SF

### Rigatura

1R

1R

5 mm

5 mm

4 mm

4 mm

### Foratura

Con 4 fori

Senza fori

Con 4 fori

Senza fori

Con 4 fori

Senza fori

### Imballo

36

36

36

36

36

36

### U.M.V

6

6

6

6

6

6

# SpilBlok® 6



## COLORI ASSORTITI\*



\*Colori non acquistabili singolarmente

**Formato**  
**A6**

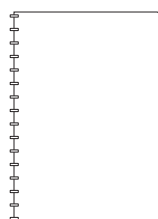

H 15 cm

L 10 cm

**Grammatura**  
**80 gr/m<sup>2</sup>**

**Fogli**  
**80**



### Codice

19716  
19717

### Rigatura

1R  
5 mm

### Foratura

Senza fori  
Senza fori

### Imballo

36  
36

### U.M.V

6  
6

# SpilBlok<sup>®</sup> 7



## COLORI ASSORTITI\*

					
Giallo	Lilla	Verde acqua	Rosso	Celeste	Arancione
					
Rosso	Nero	Blu	Giallo	Verde	Arancione
					
Giallo	Viola	Verde	Fucsia	Blu	Arancione

\*Colori non acquistabili singolarmente

**Formato**  
**A7**

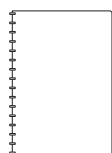

H 12 cm

L 8 cm

**Grammatura**  
**80 gr/m<sup>2</sup>**

**Fogli**  
**80**



**Codice**  
**19719**

**Rigatura**  
**5 mm**

**Foratura**  
**Senza fori**

**Imballo**  
**36**

**U.M.V**  
**6**

# SpilBlok 4e



## COLORI ASSORTITI\*



\*Colori non acquistabili singolarmente

## Formato

### A4

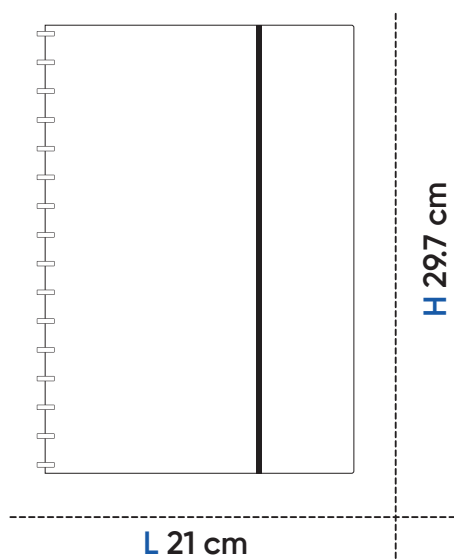

## Grammatura

### 80 gr/m<sup>2</sup>

## Fogli

### 60



### Codice

26463/CF

26463/SF

26464/CF

26464/SF

10729/CF

10729/SF

### Rigatura

1R

1R

5 mm

5 mm

4 mm

4 mm

### Foratura

Con 4 fori

Senza fori

Con 4 fori

Senza fori

Con 4 fori

Senza fori

### Imballo

36

36

36

36

36

36

### U.M.V

6

6

6

6

6

6

# SpilBlok 5e



## COLORI ASSORTITI\*



\*Colori non acquistabili singolarmente

## Formato A5

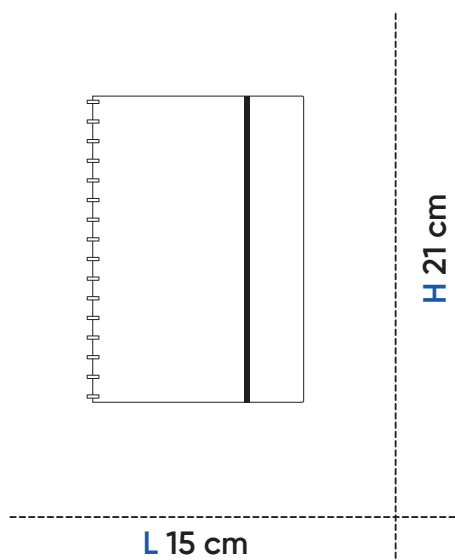

## Grammatura 80 gr/m<sup>2</sup>

## Fogli 60



### Codice

26465/CF

26465/SF

26466/CF

26466/SF

### Rigatura

1R

1R

5 mm

5 mm

### Foratura

Con 4 fori

Senza fori

Con 4 fori

Senza fori

### Imballo

36

36

36

36

### U.M.V

6

6

6

6



# SpilBlok®



## COLORI ASSORTITI\*



## Formato

9 x 12

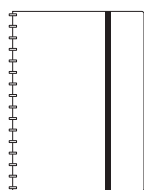

H 12 cm

L 9 cm

## Grammatura

80 gr/m<sup>2</sup>

## Fogli

60



## Codice

26470

26471

## Rigatura

1R

5 mm

## Foratura

Senza fori

Senza fori

## Imballo

36

36

## U.M.V

6

6

# SpilBlok® 6 e



## COLORI ASSORTITI\*



\*Colori non acquistabili singolarmente

## Formato A6

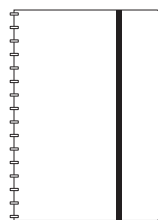

H 15 cm

L 10 cm

## Grammatura 80 gr/m<sup>2</sup>

## Fogli 60



**Codice**  
26467  
26468

**Rigatura**  
1R  
5 mm

**Foratura**  
Senza fori  
Senza fori

**Imballo**  
36  
36

**U.M.V**  
6  
6

# SpilBlok 7e



## COLORI ASSORTITI\*

					
Giallo	Lilla	Verde acqua	Rosso	Celeste	Arancione
					
Rosso	Nero	Blu	Giallo	Verde	Arancione
					
Giallo	Viola	Verde	Fucsia	Blu	Arancione

\*Colori non acquistabili singolarmente

## Formato

### A7

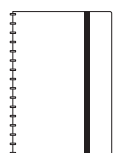

H 10.5 cm

L 7.5 cm

## Grammatura

80 gr/m<sup>2</sup>

## Fogli

60



**Codice**  
26469

**Rigatura**  
5 mm

**Foratura**  
Senza fori

**Imballo**  
36

**U.M.V**  
6

# SpilBlok<sup>®</sup> 1



## COLORI ASSORTITI\*



\*Colori non acquistabili singolarmente

## Formato

A4

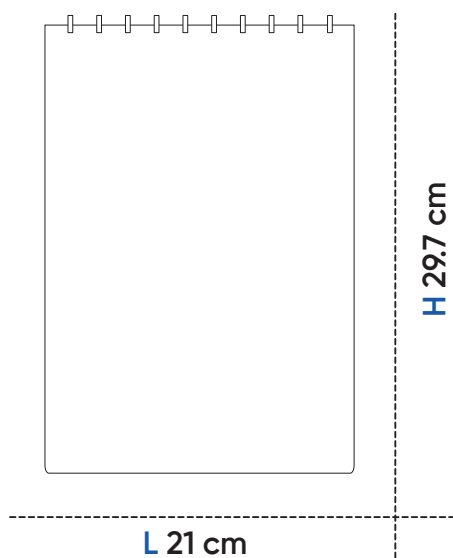

## Grammatura

80 gr/m<sup>2</sup>

## Fogli

144



I

### Codice

19720/CF

19720/SF

19721/CF

19721/SF

23033/CF

23033/CF

### Rigatura

1R

1R

5 mm

5 mm

Bianco

Bianco

### Foratura

Con 4 fori

Senza fori

Con 4 fori

Senza fori

Con 4 fori

Senza fori

### Imballo

18

18

18

18

18

18

### U.M.V

6

6

6

6

6

6

# SpilBlok<sup>®</sup> 2



## COLORI ASSORTITI\*



\*Colori non acquistabili singolarmente

## Formato A5

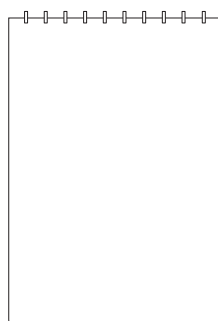

L 15 cm

H 21 cm

## Grammatura 80 gr/m<sup>2</sup>

## Fogli 144



I

### Codice

19722/SF

19723/CF

19723/SF

### Rigatura

1R

5 mm

5 mm

### Foratura

Senza fori

Con fori

Senza fori

### Imballo

36

36

36

### U.M.V

6

6

6

# SPILBLOK<sup>4BIG</sup> CLASSIC



## COLORI ASSORTITI\*



Grigio



Nero



Verde



Rosso



Blu

\*Colori non acquistabili singolarmente

## Formato

### A4

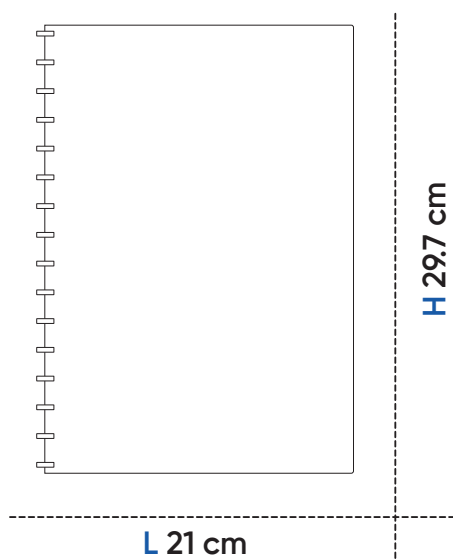

## Grammatura

### 80 gr/m<sup>2</sup>

## Fogli

### 144



### Codice

23042

23043

27609

### Rigatura

1R

5 mm

Bianco

### Foratura

Senza fori

Senza fori

Senza fori

### Imballo

20

20

20

### U.M.V

2

2

2

# SPIBLOK<sub>1</sub> CLASSIC

## COLORI ASSORTITI\*



Grigio



Nero



Verde



Rosso



Blu

\*Colori non acquistabili singolarmente

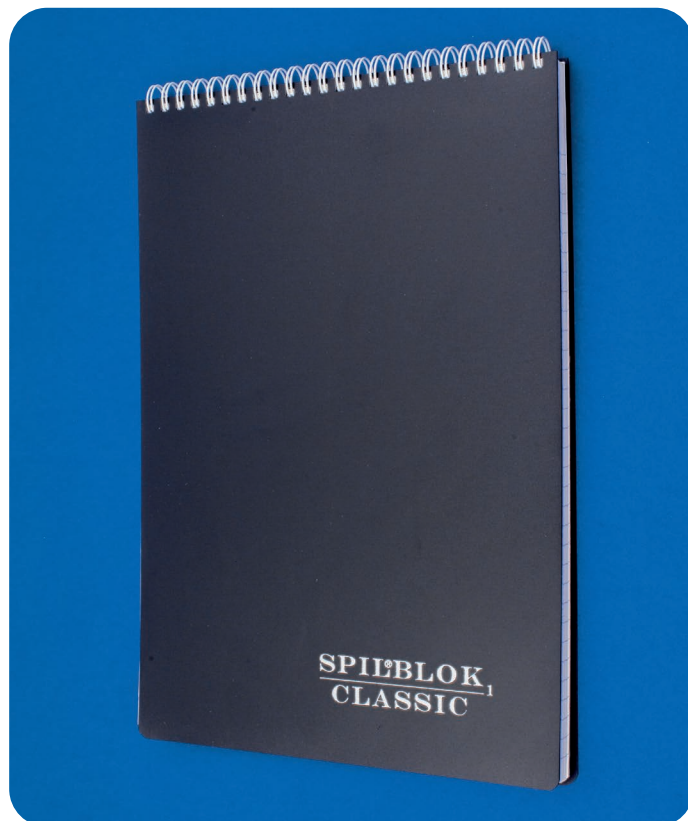

## Formato

A4

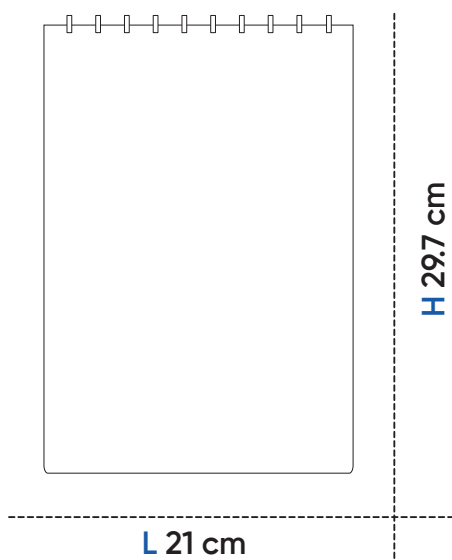

## Grammatura

80 gr/m<sup>2</sup>

## Fogli

144



### Codice

23040

23041

### Rigatura

1R

5 mm

### Foratura

Senza fori

Senza fori

### Imballo

36

36

### U.M.V

6

6

# Espositore da terra



H 38 cm  
RIMOVIBILE

H 195 cm

L 65 cm

Codice  
07992/G



*“ Crediamo che scrivere sia una parte fondamentale dell'apprendimento e un esercizio spontaneo che ha il potere di aprire la mente e accendere la creatività. ”*





 [spil\\_italia](https://www.instagram.com/spil_italia)

 [www.spil-italia.com](http://www.spil-italia.com)

 0825446649